

EPSON

HX-20 OPERATIONS MANUAL

BY

Kenneth Skier

President

SkiSoft, Inc.

Cambridge, Massachusetts

All rights reserved. No part of this publication may be reproduced, stored in a retrieval system, or transmitted, in any form or by any means, electronic, mechanical, photocopying, recording or otherwise, without the prior written permission of Epson America, Inc. No patent liability is assumed with respect to the use of the information contained herein. While every precaution has been taken in the preparation of this book, the publisher and author assume no responsibility for errors or omissions. Neither is any liability assumed for damages resulting from the use of the information contained herein.

The Source™ is a service mark of Source Telecomputing Corporation, a subsidiary of the Readers Digest Association, Inc.

CompuServe® is a registered trademark of CompuServe, Inc.

Copyright® 1982 by Epson America, Inc.
Torrance, California 90505

Federal Communications Commission Radio Frequency Interference Statement

“This equipment generates and uses radio frequency energy and if not installed and used properly, that is, in strict accordance with the manufacturer’s instructions, may cause interference to radio and television reception. It has been type tested and found to comply with the limits for a Class B computing device in accordance with the specifications in Subpart J of Part 15 of FCC Rules, which are designed to provide reasonable protection against such interference in a residential installation. However, there is no guarantee that interference will not occur in a particular installation. If this equipment does cause interference to radio or television reception, which can be determined by turning the equipment off and on, the user is encouraged to try to correct the interference by one or more of the following measures:

- Reorient the receiving antenna
- Relocate the computer with respect to the receiver
- Move the computer away from the receiver
- Plug the computer into a different outlet so that computer and receiver are on different branch circuits.

If necessary, the user should consult the dealer or an experienced radio/ television technician for additional suggestions. The user may find the following booklet prepared by the Federal Communications Commission helpful:

“How to identify and Resolve Radio-TV Interference Problems.” This booklet is available from the US Government Printing Office, Washington, D.C., 20402, Stock No. 004-000-00345-4.

CONTENTS

1 Congratulations!	1
2 Cautions	5
Case	5
Dummy cartridge	5
System bus cover	6
Circuitry cover	7
Battery charger	7
Batteries	8
Printer	9
Peripherals	9
Physical shock	10
Humidity	10
Extreme temperatures	11
3 Preparing your HX-20 for use	13
Unpacking the HX-20	13
Charging the batteries	14
Preparing the printer for use	15
Removing the printer cover	16
Inserting the paper roll	17
Inserting the ribbon cartridge	21
Replacing the printer cover	22
Adjusting the viewing angle	23
initializing memory and the calendar clock	25
Selecting a different character set	27
4 Using the HX-20	31
Turning it on	31
Viewing the menu	31
Choosing an item from the menu	33
5 The screen editor	35
The virtual screen	35
The cursor	36
Scrolling	40
Homing the cursor	40
Clearing the screen	41
Typing on the virtual screen	41
Automatic scrolling	41

Virtual screen width	42
Logical lines vs. physical lines.	43
Retyping	44
Deleting text	44
Insert mode	45
Upper and lower case.	46
Numeric mode	47
Graphic characters	49
Printing the screen	50
Using the special function keys	52
6 Connecting your HX-20 to other devices	55
-to a cassette recorder	55
-to an RS-232 device	57
-to a bar code reader	58
7 What if you have problems?	61
If you can't turn off your HX-20	61
If the menu displays garbage	62
If you encounter other problems	62
8 Storing your HX-20	63
- for a few minutes to a few hours	63
- for a few hours to a few weeks	63
-for a few weeks to a few months	63
9 Specifications	65
Architecture..	65
Expansion	67
Help!	73

Chapter 1

Congratulations!

Congratulations! You have just purchased the first of a new generation of personal computers. The *Epson HX-20* is unlike any product ever built, combining the power and usefulness of a desktop computer with the portability of a pocket calculator.

It's a go-anywhere, do-anything system designed from the start to be *user-friendly*-which means you don't have to know anything about computers to use it. Powered by its own internal batteries, with no dangling cords or external paraphernalia, the HX-20 is a compact and uncluttered system, at home in the classroom or the conference room, on your desk or in your lap.



Unlike most other personal computers, the HX-20 can store up to *seventeen* programs in its memory. (Five of these may be BASIC programs.) When you turn on the HX-20, a *menu* appears on the screen, listing the names of these programs. You can make the HX-20 run any program on the menu simply by pressing a single key.

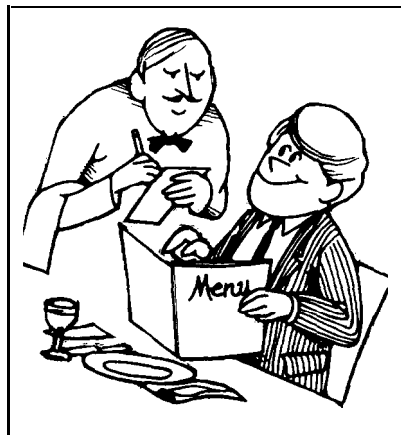

Furthermore, the HX-20 has a memory like an elephant. Unlike most personal computers, which forget any program in memory as soon as they are "powered down," the HX-20 remembers all programs in its

memory *even when you turn it off*

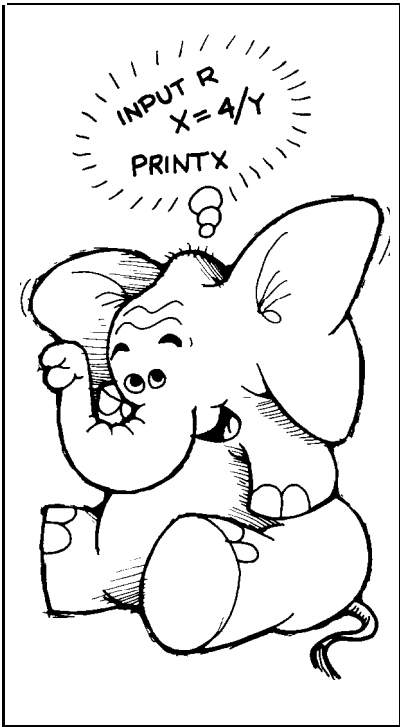

Contained within the HX-20 is an extended version of Microsoft BASIC, a powerful programming language that is easy to learn and which takes full advantage of the many special features of the HX-20. If you have no interest in programming, you can purchase programs and run them on your HX-20. But if you *do* wish to learn about programming, the accompanying *Epson HX-20 BASIC Tutorial and Reference Manual* will teach you everything you need to know. It will take you from a computer novice to an accomplished computer programmer, in only a few evenings.

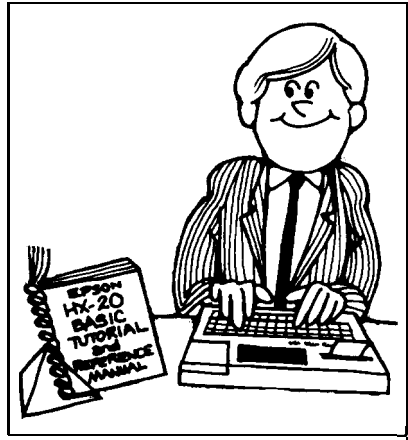

When you use the HX-20, you'll notice that its full-size, full-stroke keyboard has the feel of a fine piece of office equipment, and that its programmable special function keys make it a snap to develop programs that are extremely easy to use. You'll also appreciate its built-in screen and printer. They display *graphics* as well as numbers, punctuation marks, and upper and lower case letters.

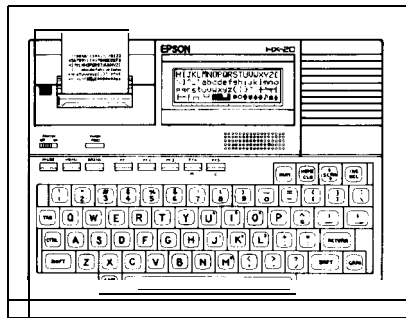

You may tailor the HX-20 to certain applications, such as word processing or telecommunications, by purchasing a tiny circuit called an *option ROM*. An option ROM will fit inside the HX-20, enhancing it

permanently with the desired capabilities. Only one option ROM can fit inside the HX-20 at a time, but it's a powerful means of customizing the HX-20 for a desired application-without diminishing in any way its ability to run BASIC programs or to accept *option cartridges*.

Option cartridges also tailor the HX-20 for specific applications. You can install a cartridge in moments, simply by sliding it into a recessed compartment in the case of the HX-20. Insert a *program* cartridge for one or more ready-to-run applications programs; or slide in the *micro-cassette* cartridge, which contains a complete microcassette recorder suitable for storing programs and data files.

If your applications require more memory than the HX-20 features, just attach an *expansion unit*, which virtually doubles the read-write memory and permanent memory of the system.

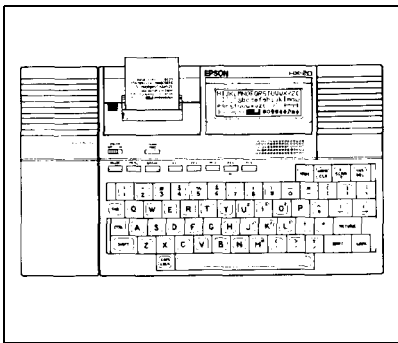

Should you decide to expand the capabilities of your HX-20 even further, you may connect it to such external devices as:

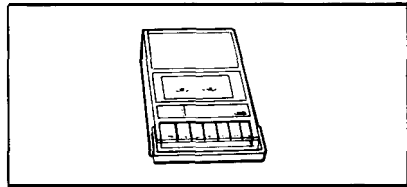

-an ordinary *cassette recorder*, for permanent storage of programs and data;

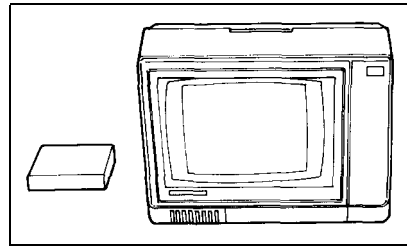

-a *display controller*, which enables the HX-20 to display text and graphics on your television set or on a video monitor;

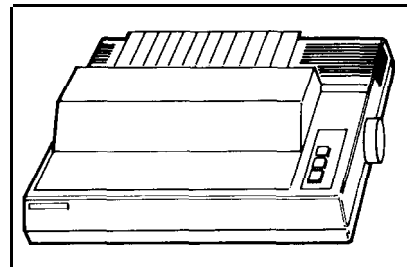

-a *printer*, for full-page printouts of text and graphics;

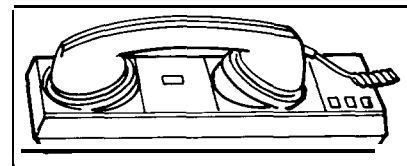

-a *modem* or *acoustic coupler*, to enable your HX-20 to communicate over telephone lines to other computers and networks such as *CompuServe@* and *The Source*”;

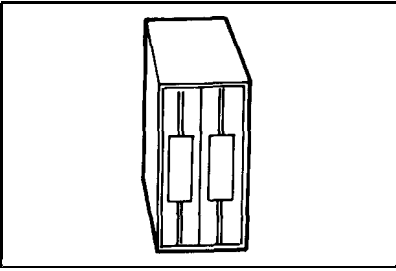

As you can see, the HX-20 is powerful, portable, easy to use and expandable. Whether you wish to use it for school, for business, or just for fun, you could hardly choose a more *personal* personal computer. So, once again, Congratulations!

-*one or more floppy-disk* units, which may store dozens or hundreds of programs and data files *on-line*, for virtually instant access;

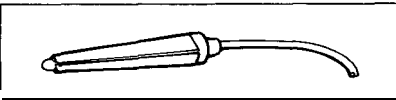

-a *bar code reader*, to scan bar-coded programs, songs, and data sheets.

Chapter 2

Cautions

The HX-20 is not a toy. Although it is solid and well-built, it is not invulnerable. Treat it with the care it deserves, and it should provide you with years of reliable service.

The warnings on these pages concern only the HX-20. If you connect your HX-20 to any peripherals, be sure to heed any warnings contained within the documentation for those peripherals.

(Note: failure to observe the following cautions may void the warranty on your HX-20.)

Never disassemble the case

There are *no* parts inside your HX-20 that you can service or replace by yourself. If you remove the screws that hold the case together, you will risk damaging the static-sensitive circuitry and/or the batteries.

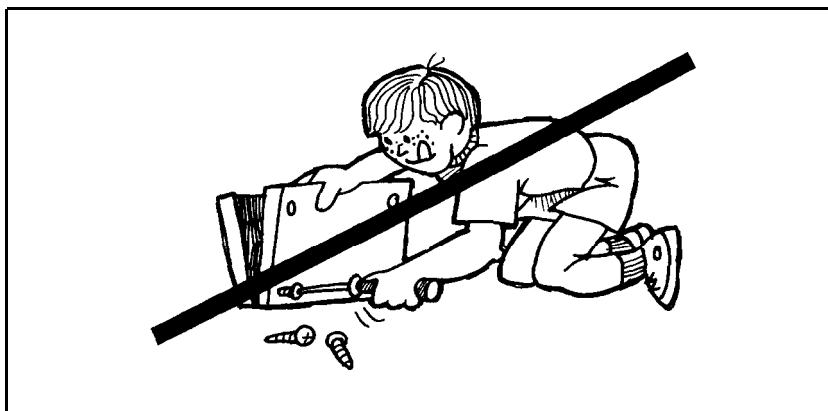

Never disassemble the case

Leave the dummy cartridge in place

In the upper right corner of your HX-20, you will notice a dummy cartridge.

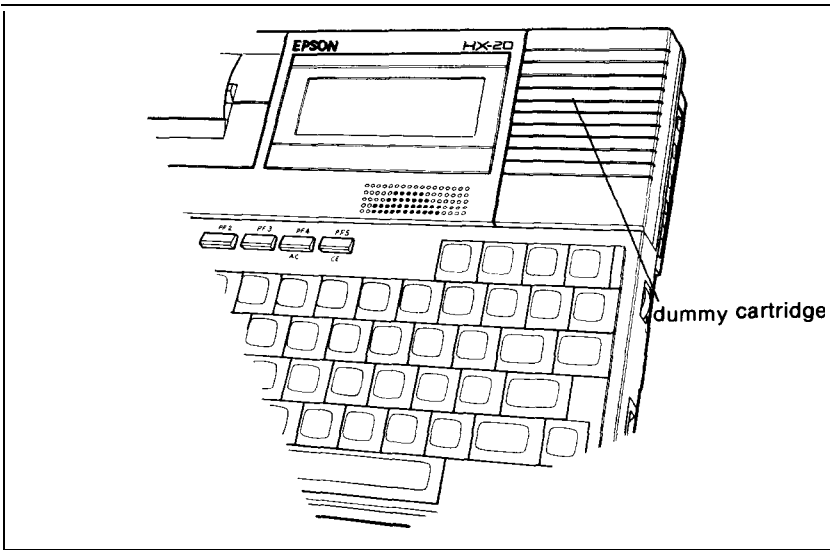

Leave the dummy cartridge in place

If you purchase an option cartridge containing a program or a microcassette recorder, then you will need to remove the dummy cartridge in order to insert the option cartridge. But until then, please leave the dummy cartridge in place.

When no cartridge is in place, one of the HX-20's connectors is exposed. Static electricity or metal objects contacting this connector can damage the HX-20's circuitry. By covering up this connector, the dummy cartridge prevents such mishaps.

Do not remove the system bus cover

On the left side of your HX-20, you will notice a small strip of dark plastic. This covers up a connector called the *system bus*.

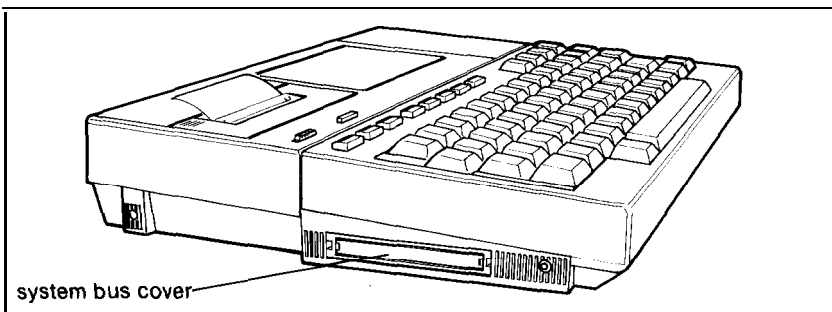

Do not remove the system bus cover

When the system bus is exposed, you will run the risk of damaging your HX-20 through exposure to static electricity, metal objects, and other hazards. The system bus cover protects your HX-20. Carefully remove it only to install the HX-20 *expansion unit*.

Treat the circuit cover with care

If you turn your HX-20 upside down, you will notice something that looks like a trap door. This covers the HX-20's internal circuitry.

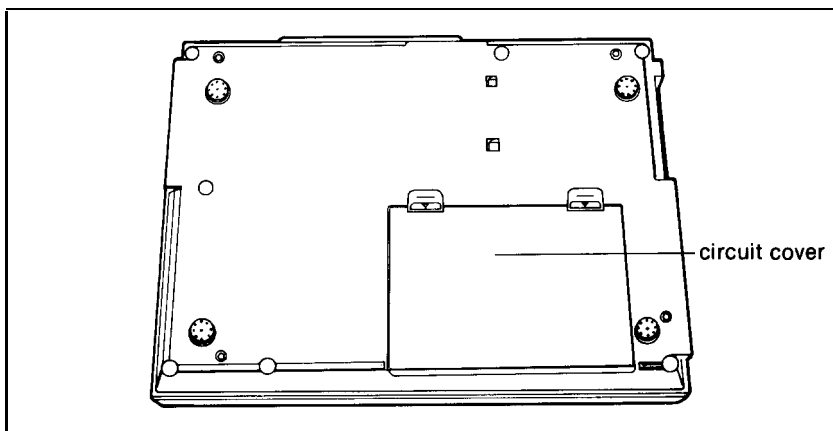

Treat the circuit cover with care

PLEASE NOTE: You should not remove this cover yourself! Removing it exposes the static-sensitive circuit to possible damage. *Your warranty will become void if you attempt to modify, adjust, add, or insert any ROM or other part or device in this compartment.*

This cover should only be removed by an authorized Epson dealer or service center and for one of two reasons:

- 1) to install an option ROM.
- 2.) to select a different character set (see Page 27).

Also, do not operate the HX-20 with the circuit cover removed. Doing so increases the chance of damage to the circuit, and may cause the HX-20 to interfere with television or radio reception nearby.

Use only the HX-20 AC adapter to charge HX-20 batteries

Your HX-20 comes with a device labelled AC ADAPTER. This unit is designed to charge the batteries in your HX-20. *It is not designed to run your HX-20 directly from AC current.*

In all cases, you should operate the HX-20 using *only* its internal nickel-cadmium batteries.

You may own other electronic products whose accessories include an AC adapter or a battery charger that looks much like the HX-20 battery charger. **DO NOT USE** any of these devices with your HX-20. Their electrical characteristics will almost certainly be quite different from those of the HX-20 battery charger. (This is true even of chargers and adapters rated at 6 volts, and equipped with

plugs identical to the one on the HX-20 battery charger.)

Using any battery charger other than the one that came with your HX-20 may damage the HX-20 and/ or its batteries and could void your warranty.

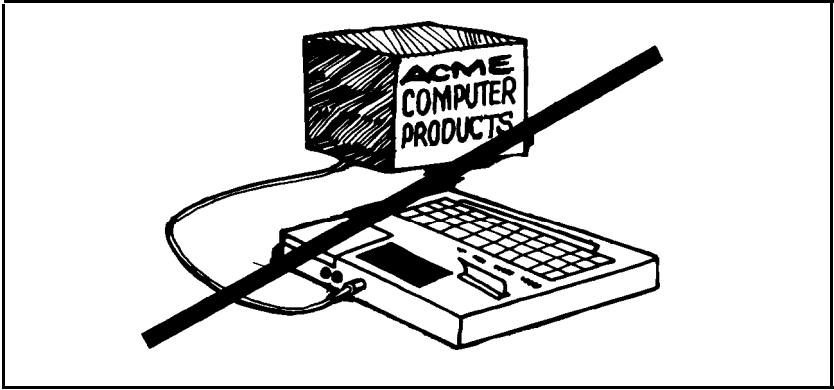

Use only the HX-20 AC adapter to charge HX-20 batteries

Don't overcharge the batteries

If you operate the HX-20 with the battery charger connected, eventually you will overcharge the batteries.

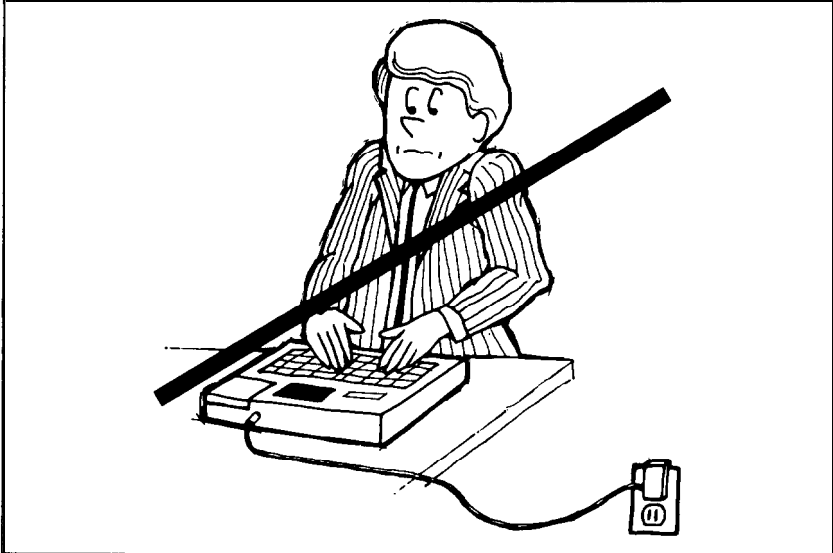

Do not operate the HX-20 with the battery charger connected

When its batteries need to be recharged, the HX-20 will flash "CHARGE BATTERY" on the screen sixty times, and then shut off. When you see the "CHARGE BATTERY" warning, turn off the power switch and charge the HX-20 for eight hours. If you

recharge the HX-20 before you see that message, you will only shorten the useful life of the batteries.

Charging the batteries for more than eight hours at a time will shorten their life. Charging them continuously for more than seven days can destroy them.

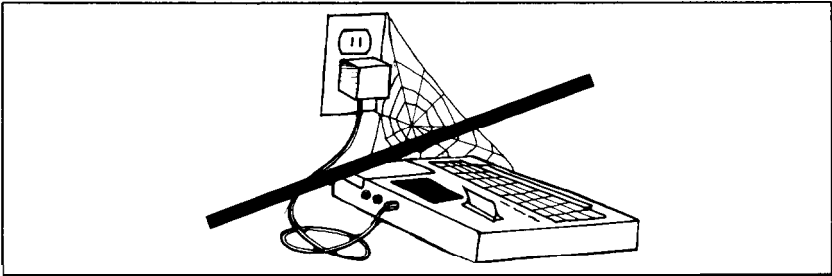

Don't overcharge the batteries

If your batteries fail to hold a charge, take your HX-20 to an Epson Service Center. **DO NOT ATTEMPT TO REMOVE THE BATTERIES YOURSELF**, or you could damage your HX-20.

Don't pull on the paper when the printer is active

You may damage the HX-20's built-in microprinter if you pull on the paper while the printer is working.

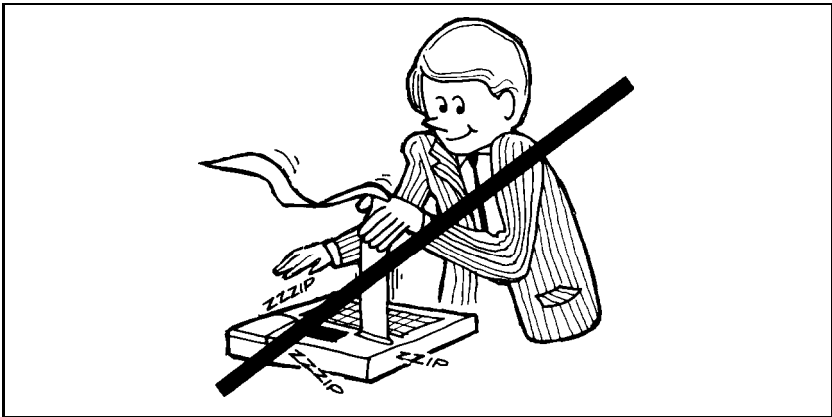

Don't pull on the paper when the printer is active

You may, however, pull on the paper when the printer is inactive; this will cause no damage to the printer.

Connect the HX-20 only to appropriate peripherals

The sockets on the back of the HX-20 enable you to connect it to an Epson disk drive or an RS-232 serial device such as a modem or a printer. Sockets on the side of the HX-20 enable you to plug in a bar-code reader or a cassette recorder.

Do not plug any device into these sockets unless it conforms to the interface specifications listed at the back of this manual.

Plugging in a device that does not conform to these specifications may damage the HX-20 and/or the device you plug in, and may void your warranty.

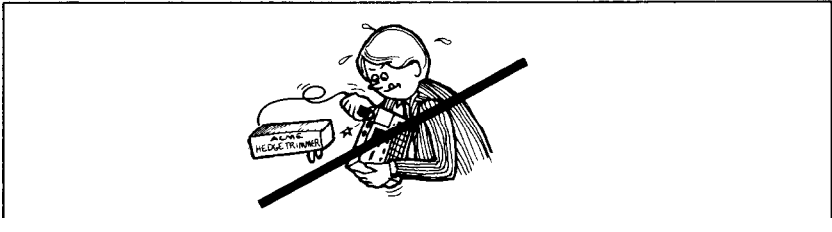

Connect the HX-20 only to appropriate peripherals

Protect the HX-20 from physical shock

Don't drop your HX-20, or let it shake about. Like any other electronic product, the HX-20 can be damaged by such treatment. Pack it in its original box, using the original packing materials, whenever you ship it.



Protect the HX-20 from physical shock

Protect the HX-20 from extreme humidity

The HX-20 is designed for use in conditions where the humidity does not exceed 80%. Exposure to humidity exceeding this level can impair the performance of the HX-20, or damage it. Exposure to water can create a potential shock hazard.



Protect the HX-20 from extreme humidity

Protect the HX-20 from extreme heat and cold

The HX-20 is designed for use in conditions where the temperature is below 95° F (35° C), and above 41°F (5° C).

The HX-20 will not work reliably outside of this temperature range.

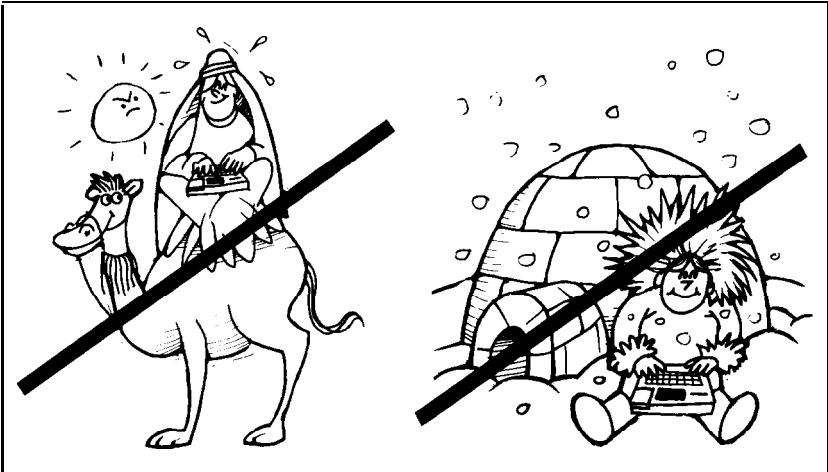

Protect the HX-20 from extreme heat and cold

Storing the HX-20 in conditions that are too hot or too cold may damage it permanently.

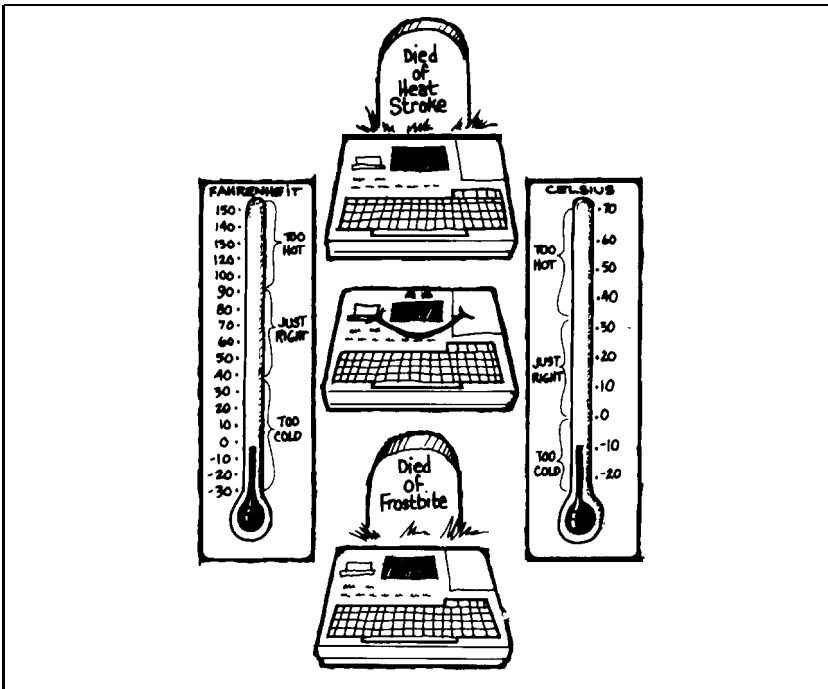

Chapter 3

Preparing your HX-20 for use

Before you use your HX-20 for the first time, you must take several steps:

- 1) Unpack it.
- 2) Charge the batteries.
- 3) Put paper and a ribbon in the printer.
- 4) Adjust the LCD display.
- 5) Initialize memory and the calendar clock.

If you need to work with special symbols, you might also wish to select a different character set. See page 27.

Unpacking the HX-20

Remove the HX-20, the battery charger, and all packing materials from the box. Check the packing materials for small parts and papers.

DO NOT DISCARD THE PACKING MATERIALS!

You will need them if you ever ship the HX-20, to protect it during shipment.

You should have the following:

- 1) The Epson HX-20 computer and carrying case.
- 2) The battery charger.

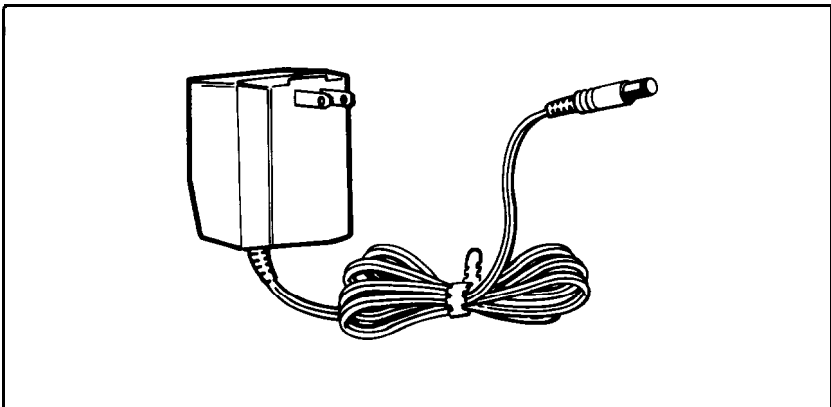

3) A roll of paper for the printer.

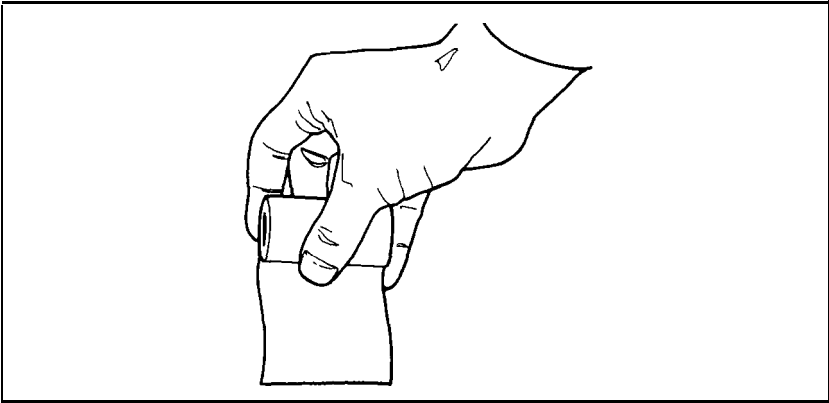

4) A ribbon cartridge for the printer.

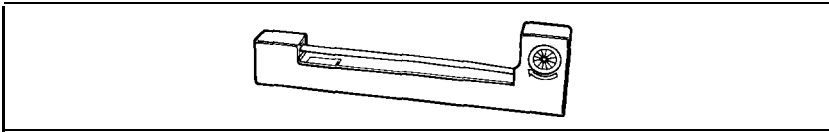

5) This manual.

6) The *Epson HX-20 BASIC Tutorial and Reference Manual*.

7) The registration card.

8) A warning sheet concerning the battery charger.

Fill out the registration card at the time of purchase and mail it to Epson.

With your registration card on file, Epson can provide continuing software and hardware support to help you in using your HX-20.

Charging the batteries

The nickel-cadmium batteries in your HX-20 hold very little charge when they are new. So charge them now, before using the HX-20. A full charge is necessary to maintain maximum battery efficiency. For optimum battery life, only recharge the batteries when the HX-20 tells you to do so.

Plug the battery charger into an AC outlet:

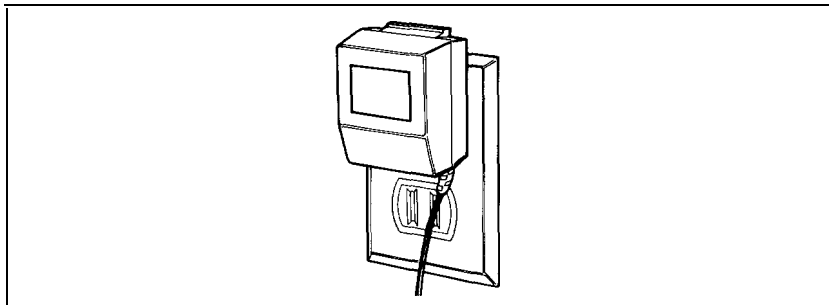

Uncoil the battery charger cable. At the free end of this cable is a small, cylindrical plug:

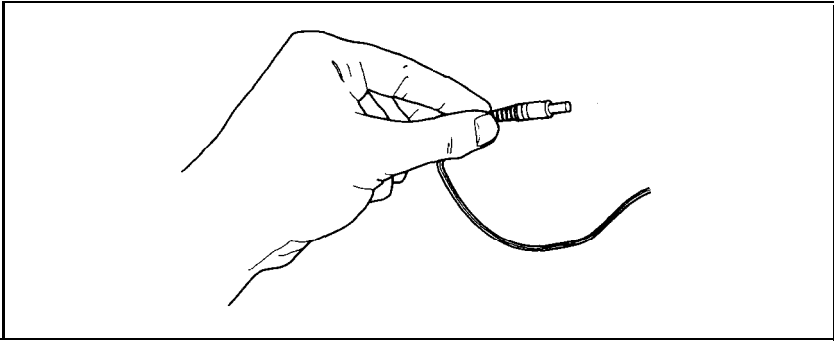

Insert this plug into the socket labelled “ADAPTER” on the back of the HX-20:

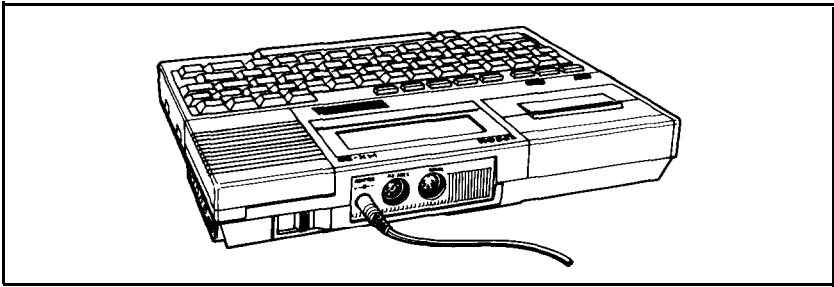

DO NOT TURN ON THE HX-20! If you leave your HX-20 power on, your batteries will not be fully charged at the end of eight hours.

The batteries in the HX-20 are now charging. Allow them to obtain a full charge for eight (8) hours. Then disconnect the battery charger from the AC outlet, and unplug it from the HX-20.

Preparing the printer for use

The HX-20 features a built-in microprinter which can print text and graphics. The printer mechanism and controls are located in the upper left corner of the HX-20.

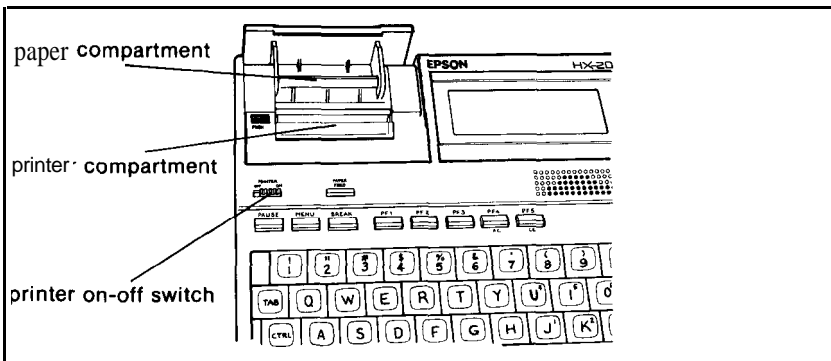

When the HX-20 is shipped from the factory, the ribbon and paper are not installed in the printer. To prepare the printer for use, you must perform the following steps:

- 1) Remove the printer cover.
- 2) Insert the paper roll.
- 3) Insert the ribbon cartridge.
- 4) Replace the printer cover.

The only tools you will need are your fingers.

Removing the printer cover

Four small grooves and the word “PUSH” are embossed on the printer cover. With the index finger of your left hand, push gently on these grooves:

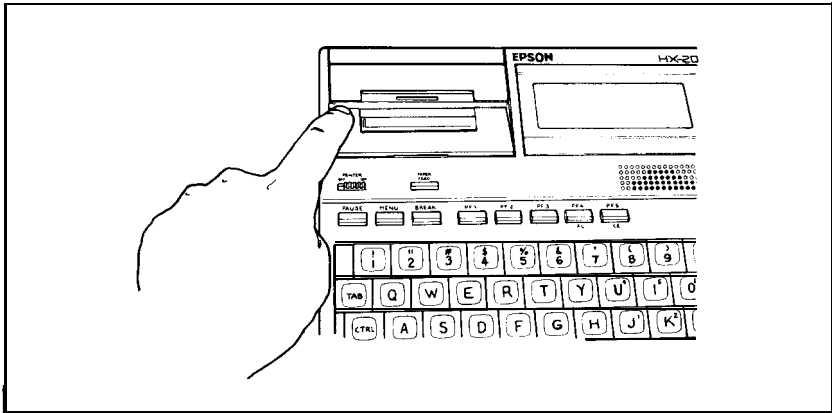

The printer cover will tilt:

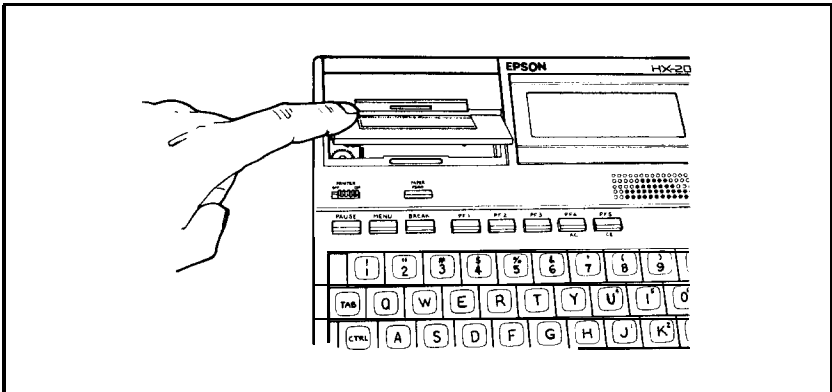

Using the thumb of your left hand, pull up on the printer cover:

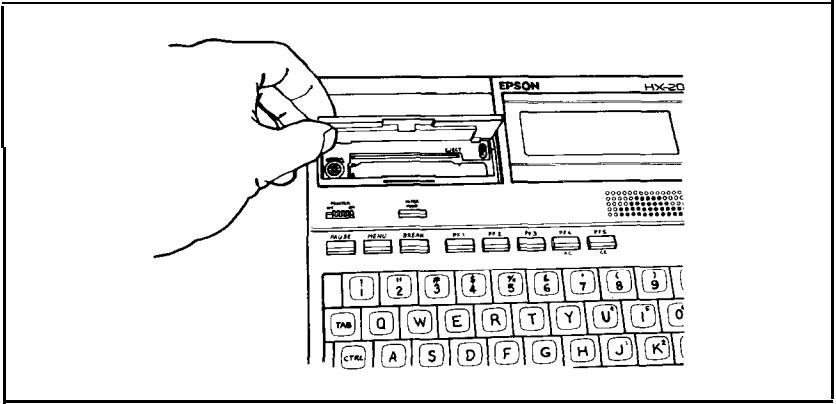

When you have tilted the printer cover up to a near-vertical position, you may lift it completely from the HX-20:

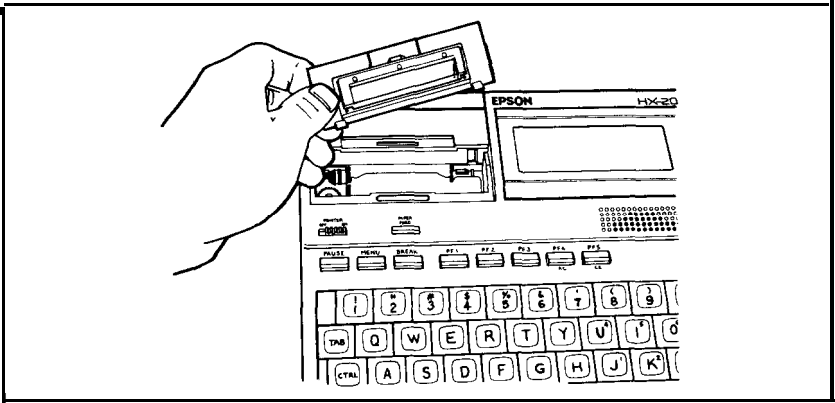

Now you can look directly into the printer compartment.

Inserting the paper roll

Note the ON-OFF switch on the right side of the HX-20. Turn the HX-20 on, by sliding this switch away from you, towards the back of the HX-20:

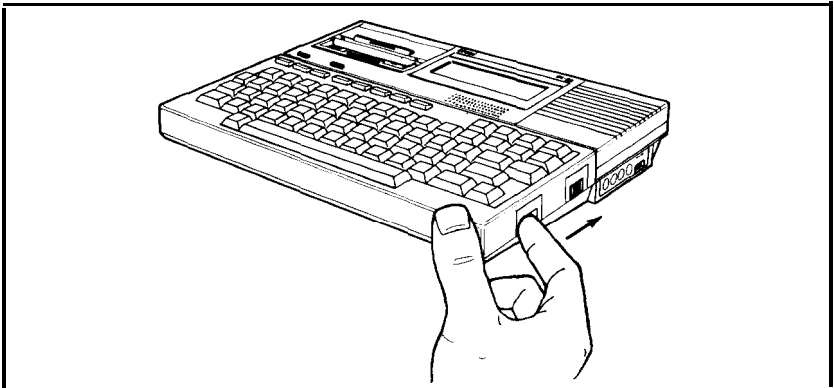

(Pay no attention to the screen at this point.)

Turn the printer on, by sliding the PRINTER ON-OFF switch to the right:

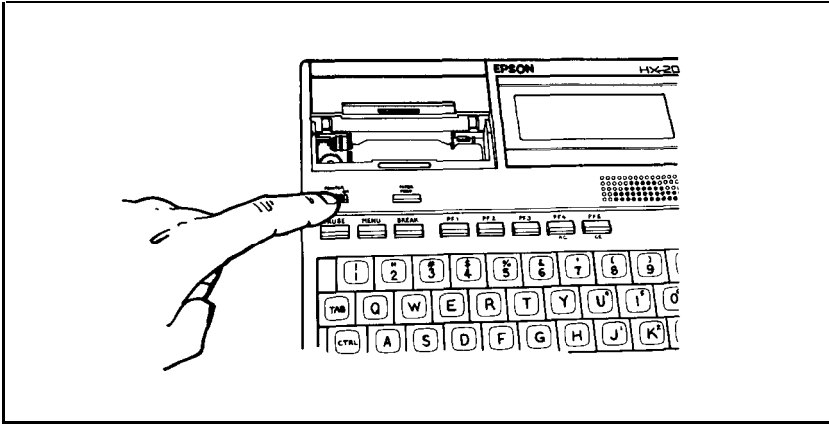

The printer will remain inactive.

Now, with your thumb on the front of the paper cover, and your other fingers on the back, pull the paper cover up, rotating it towards the back of the HX-20:

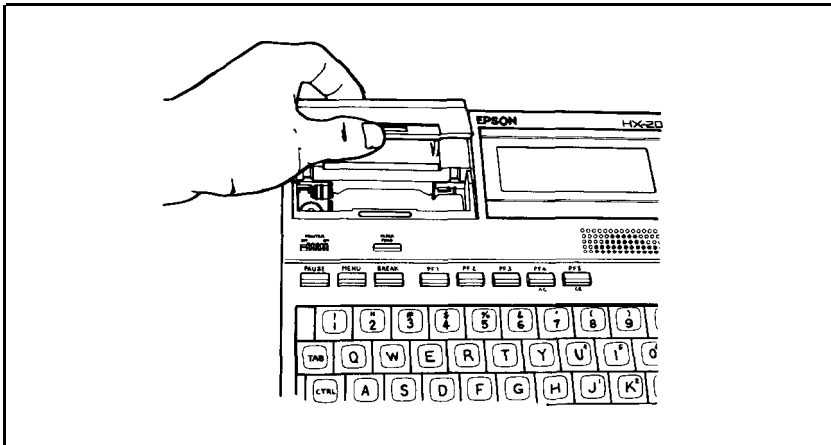

(Unlike the printer cover, which is removable, the paper cover may *not* be removed from the HX-20.)

You may now look into the paper compartment, which is empty except for a strip of fabric.

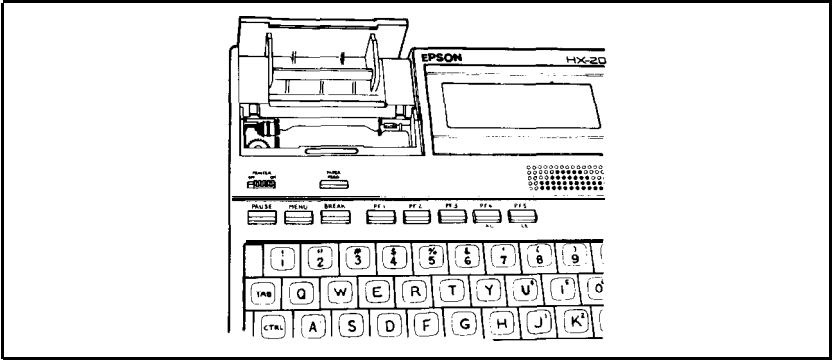

Now you need the roll of printer paper that came with your HX-20. When you use it up, replace it with the same kind of paper (available at your Epson dealer). Do not use any other paper, as it may jam or otherwise damage the printer.

Unroll several inches of this paper:

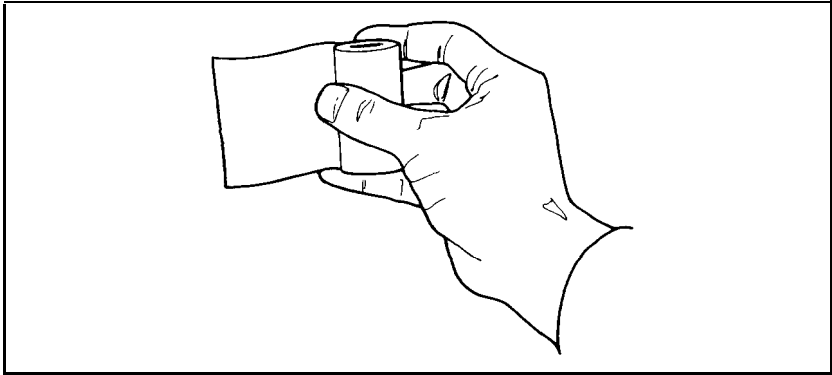

Slide the paper through the slot connecting the paper compartment and the printer compartment. You can slide it in about one-quarter inch before it stops:

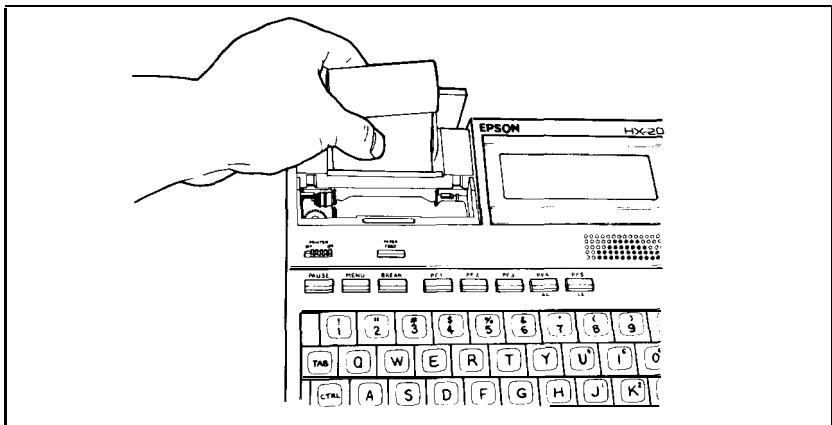

While holding the paper in place, press the PAPER FEED button. The printer will activate, and a rubber roller will pull the paper into the printer compartment. Hold the PAPER FEED button down until the paper emerges from the top of the printer mechanism. When an inch of paper has emerged from the top of the printer, release the PAPER FEED button:

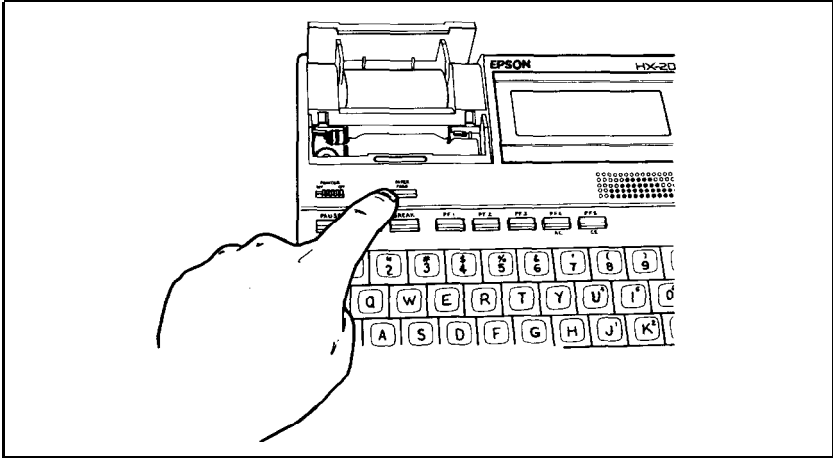

Now pull the paper through the printer, until several inches are exposed:

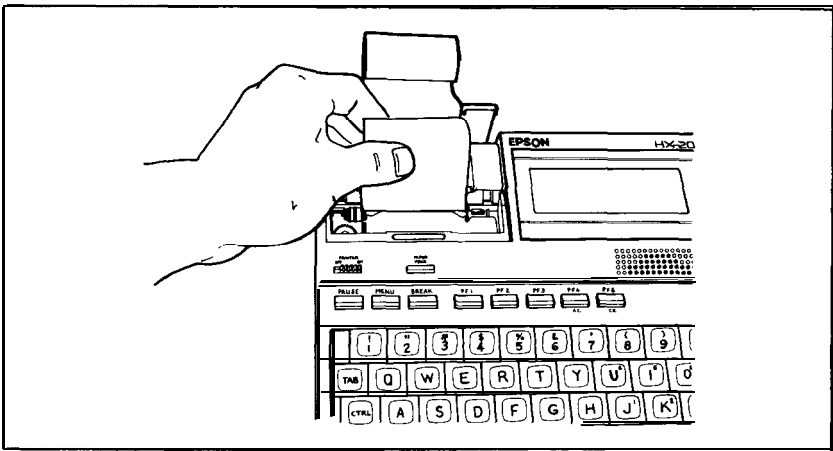

Put the roll of paper into the paper compartment on top of the strip of fabric. If you ever wish to remove the paper roll, lift the fabric strip.

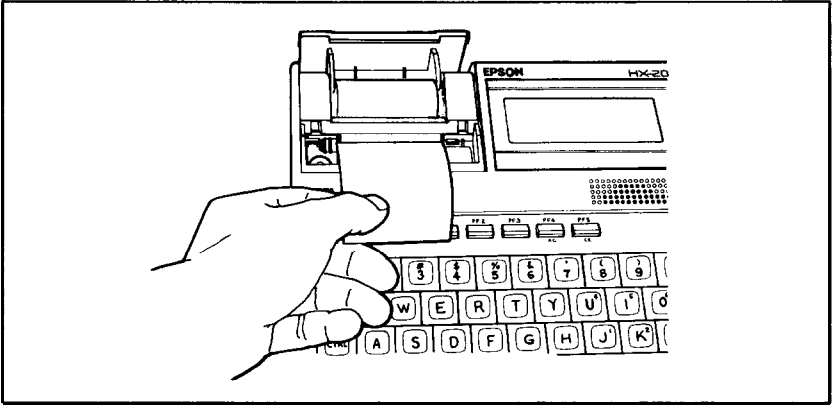

Close the paper compartment by pulling the paper cover all the way forward. Be sure that you don't close the paper cover on the free end of the paper roll.

Inserting the ribbon cartridge

Packaged with your HX-20 is an L-shaped ink ribbon cartridge:

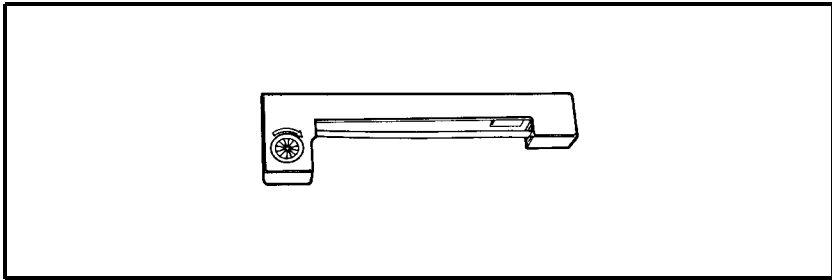

Holding it as shown, you may slide it over the paper and into the printer compartment. Be sure the paper goes between the ribbon cartridge and the ink ribbon.

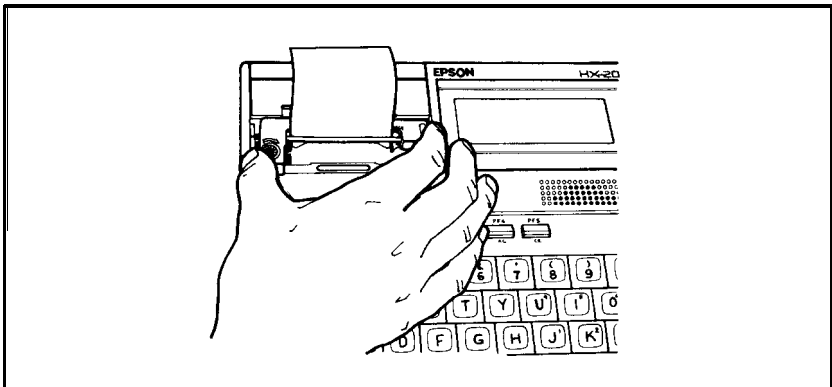

Push the ribbon cartridge down into the printer compartment, until the top surface of the ribbon cartridge is level with the metal plate.

(Do not be concerned if the ribbon has some slack and rests on top of the metal plate.)

The ribbon cartridge is now installed.

(Eventually, the microprinter will produce very faint copy, and you will need to replace the ribbon. To remove a ribbon from your HX-20, press on the word "PUSH" embossed on the right side of the ribbon. The left side of the ribbon will pop up, and you can remove it. Then install a new one, which you may purchase at your Epson dealer.)

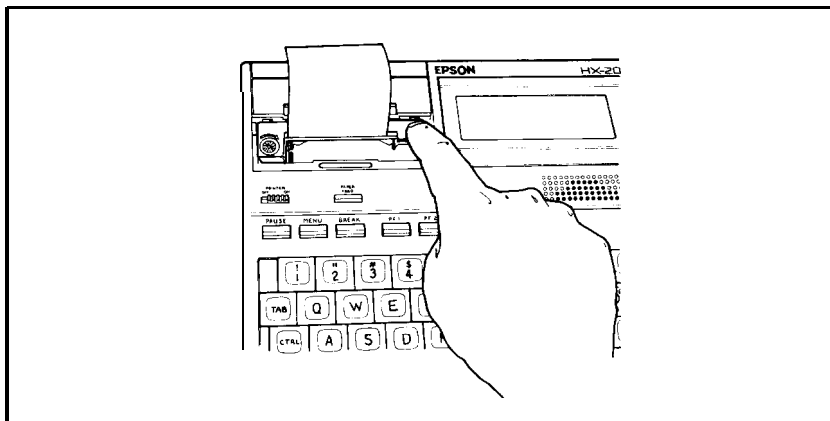

Note: If you get ribbon ink on the case of the HX-20, wipe it off immediately. Once it dries, it's hard to remove.

Replacing the printer cover

Slide the paper through the slot in the printer cover:

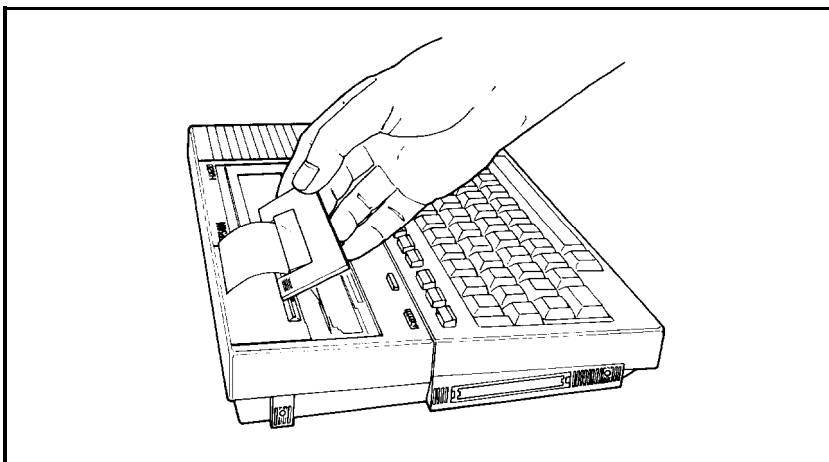

Push the back of the printer cover down and into place:

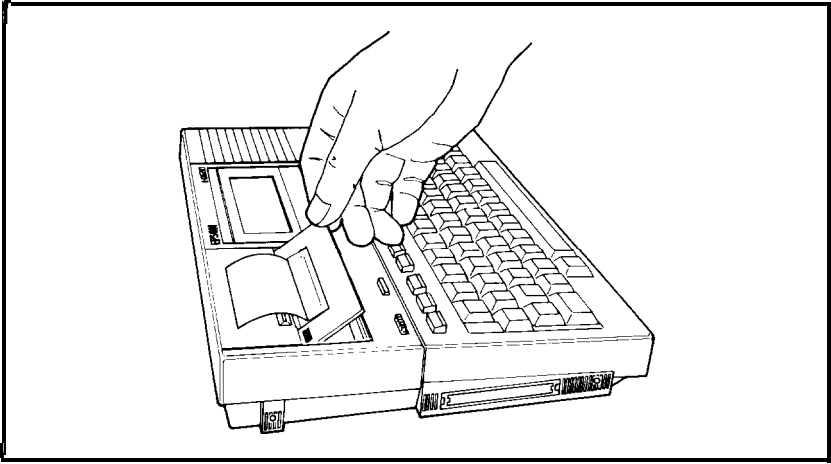

Press the front of the printer cover down:

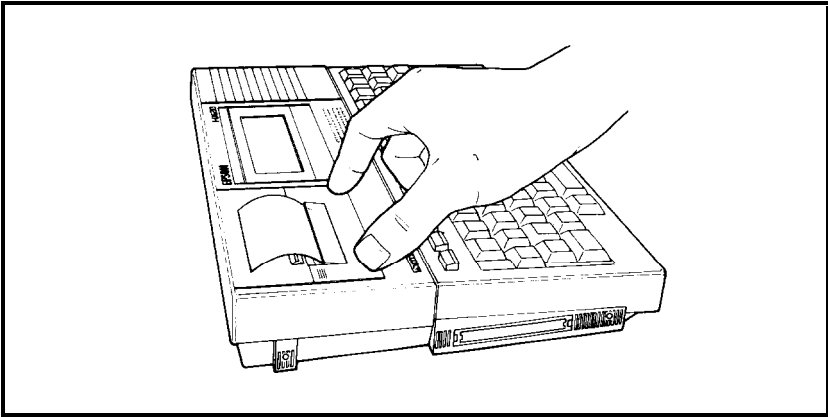

The printer cover is now in place.

Adjusting the viewing angle

The HX-20 uses an LCD (Liquid Crystal Display) screen. Unlike a television or movie screen, an LCD screen can only be viewed from within a narrow range of angles. You can prove this to yourself by looking at the HX-20 screen and moving your head forward and backward, to view the screen from various angles:

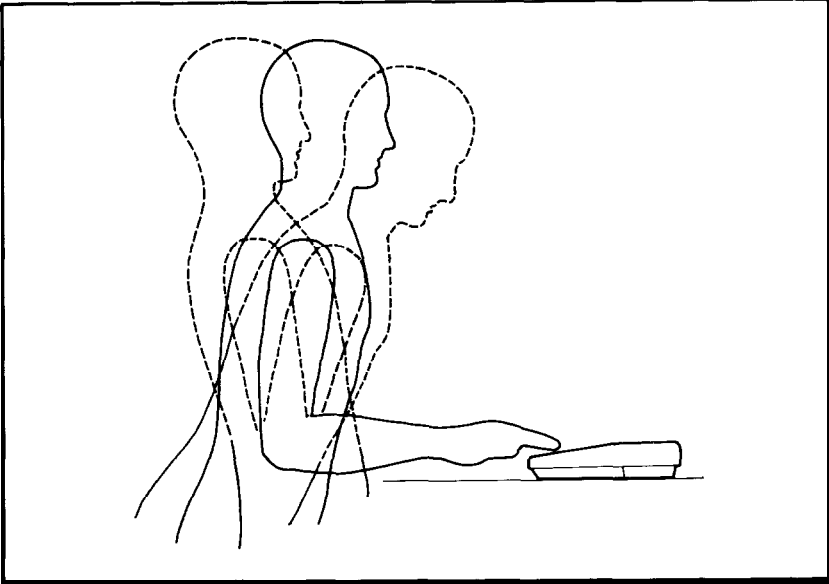

At one angle you might not see any text at all on the screen. At another angle the entire screen may look black. But you will discover an *optimal viewing angle*: an angle from which you will find it very easy to read the screen.

Nevertheless, you won't have to sit in any particular position while using the HX-20. To adjust the LCD screen to *your* position, place your finger on the VIEW ANGLE adjustment knob, located on the right side of the HX-20:

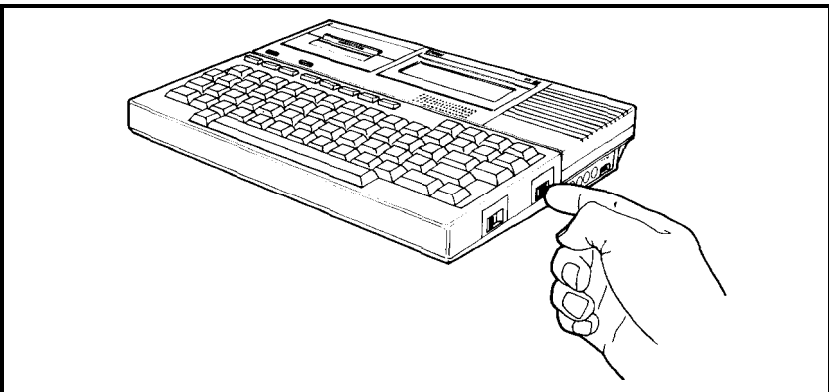

Turn the VIEW ANGLE adjustment knob until the screen shows you crisp black characters against a light gray background.

(If you view the LCD screen from a different angle, you may need to adjust the viewing angle again. You might also have to adjust the VIEW ANGLE if the temperature changes, because the LCD display is temperature-sensitive.)

Initializing memory and the calendar clock

Before you use the HX-20 for the first time, you must *initialize* its memory and its calendar clock. (If your HX-20 is not on now, turn it on.) The screen will look like this:

```
CTRL/@Initialize
1 MONITOR
2 BASIC
```

(Note: there may be various letters and symbols under “1 MONITOR”. Ignore them.)

If you can't read the text on your screen, adjust the VIEW ANGLE knob on the right side of the HX-20.

According to this menu, you must type CTRL/ @ to initialize the system. To do so, hold down the CTRL key (located at the left edge of the keyboard) with one finger. While you are holding it down, press the @ key.

You may now release both keys. The screen will display:

```
Enter DATE and TIME
MMDDYYHHMMSS↓
=
Press BREAK to abort
```

You have two choices now. You may initialize memory and the calendar clock, or you may decide that you don't wish to do so. Your choice will depend on how long you've been using the HX-20.

If your HX-20 is new, then of course you will want to initialize the system. But if you've been using the HX-20 for a while, and only pressed CTRL/ @ by mistake while looking at the menu, then you will *not* want to initialize the system. To do so would cause the HX-20 to lose all programs and data you have already entered into its memory.

If you do *not* want to initialize the system now, press the red BREAK key, or the MENU key, and the HX-20 will again display its menu. All programs and data previously entered into the HX-20 will still be in its memory.

If you *do* want to initialize the system, then you must now enter the date and time. This will set the HX-20's built-in calendar clock, enabling it to keep track of the date and time from this moment on, whether the HX-20 is turned on or not.

Figure 3-1 shows the particular form you must use to specify the date and time:

Figure 3-1

Format for Specifying Date and Time

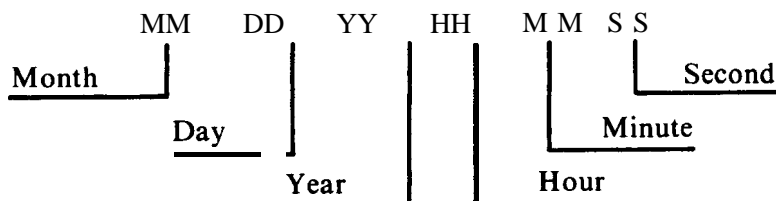

You must enter two digits for each of these units of time. For example, let's say that you are reading this in the month of January. Even though it's the first month of the year, you may not specify the month with a "1". The HX-20 expects two digits, so you must enter "01" for the month.

The hour (HH) is based on a 24-hour clock. Thus, midnight is 00, noon is 12, and 9 PM is 21.

Let's say that it is now nine minutes and thirty-five seconds after two o'clock on the afternoon of January third, 1983. What numbers will you enter to specify the date and time?

The date is 1/3/83 = 010383

The time is 2:09:35 PM = 140935

So you should type:

010383140935

and press the **RETURN** key.

Press **BREAK** or **MENU** at any *time* before pressing **RETURN** and you will abort the initialization process.

Note that no spaces, slashes, or colons separate the numbers representing month, day, year, hour, minute, and second. The numbers just run together. So you must be very careful entering them. If you make a mistake entering the date or time, press the **INS DEL** key or **CTRL/H**. The screen will clear and you may start over.

When you have typed in the date and time and pressed the **RETURN** key, the HX-20 will set its calendar clock appropriately. Then it will clear all programs and data from its memory. When it has done so, it will display the menu again. Now the menu will look like this:

```
CTRL/@Initialize
1 MONITOR
2 BASIC
```

Your HX-20 is now ready for use.

Selecting a different character set

Please note: The following information is for *dealer reference* only! The circuit cover should be removed only by an authorized Epson dealer or service center. Removing it yourself will void your warranty. You *may* select special character sets by using HX-20 software; see *The HX-20 BASIC Tutorial and Reference Manual*.

The HX-20 can display and print special characters required by users in a number of different countries. (See Table 3-1.)

TABLE 3-1
International Character Sets

Country	U.S.A.	France	Germany	England	Denmark	Sweden	Italy	Spain
Hex. code								
23	#	#	#	£	#	#	#	¤
24	\$	¢	§	£	\$	¤	\$	\$
40	@	®	§	@	@	é	@	@
5B	[°	Ä	[Æ	Ä	°	¡
5C	\	¶	ö	\	ø	ö	\	ñ
5D]	§	Ü]	À	À	é	¿
5E	^	^	^	^	^	Ü	^	^
60	<	<	<	<	<	é	ú	<
7B	<	é	ä	<	æ	ä	á	·
7C		ü	ö		ø	ö	ó	ñ
7D	}	é	ü	}	ä	ä	é	}
7E	~	·	ß	~	~	ü	í	~

To use any non-USA character set, touch a grounded surface such as a cold water pipe and then remove the circuitry cover on the bottom of the HX-20.

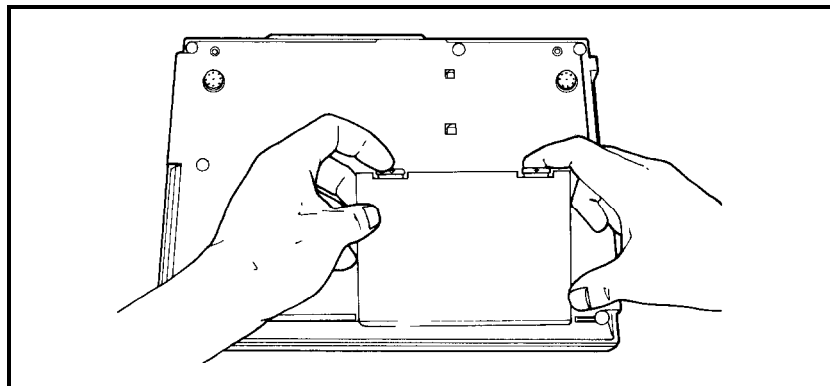

You will see a shiny, flexible flap. Carefully lift this up and out of the way.

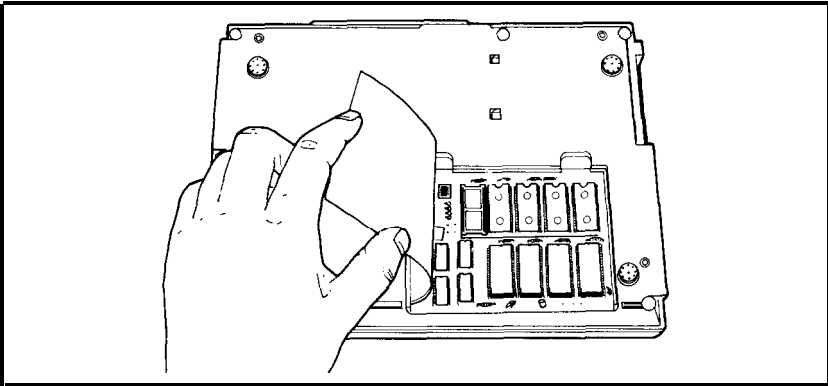

One component, called a DIP switch, looks like this (enlarged to show detail):

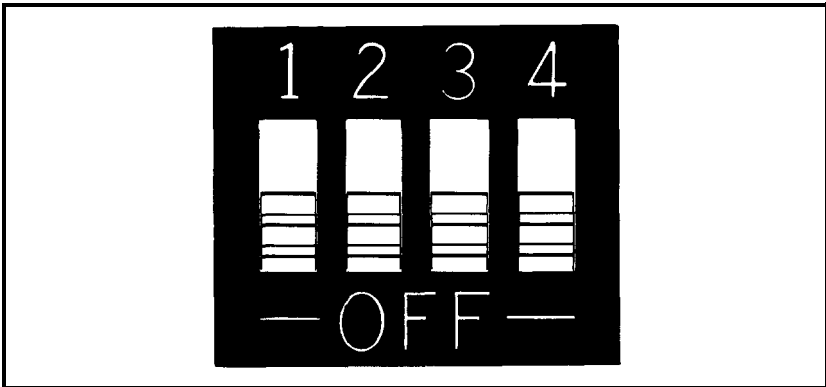

The DIP switch is actually a set of four switches. To specify the character set of a given country, look up the appropriate switch settings in Table 3-2, and set the individual switches with a ball point pen or similar object.

TABLE 3-2
DIP Switch Settings for
International Character Sets

<u>Desired Country</u>	<u>Switch 1</u>	<u>Switch 2</u>	<u>Switch 3</u>
Denmark	On	On	Off
England	Off	Off	On
France	Off	On	On
Germany	On	Off	On
Italy	On	Off	Off
Spain	Off	Off	Off
Sweden	Off	On	Off
USA	On	On	On

(Switch 4 has no effect on the HX-20's character set. Leave it in the **off** position.)

When you have adjusted the DIP switch for the desired character set, let the shiny flap fall back into place, and put the circuitry cover back into position.

Chapter 4

Using the HX-20

Once you have prepared the HX-20 for use, you may use it anywhere, at any time. Just turn it on, view the menu, and choose an item from the menu.

Turning it on

To turn on the HX-20, find the ON-OFF switch on the right side of the HX-20, and push it towards the back of the HX-20:

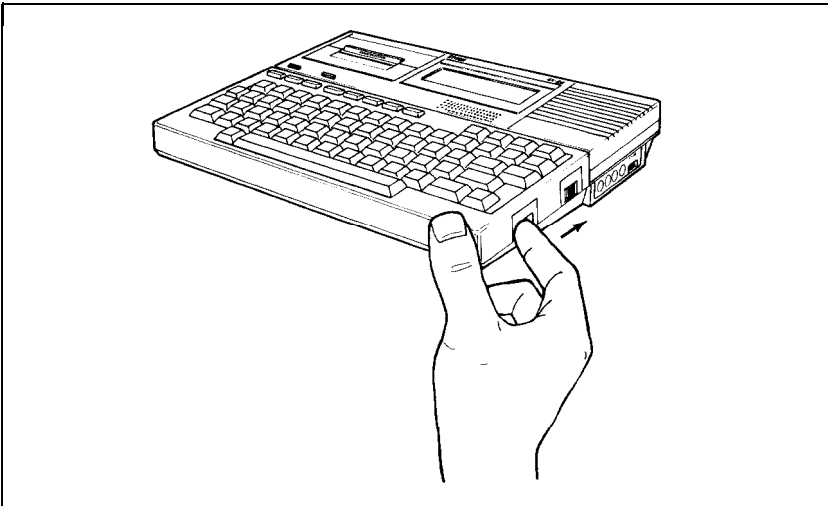

A menu will appear on the screen.

(If you can't see the menu clearly, don't be concerned; this only means that you must adjust the screen angle. See page 23.)

Viewing the menu

Each time you turn on the HX-20, a *menu* appears on the screen. This menu lists a number of jobs the HX-20 may perform for you. The menu may be very short, like this one:

```
CTRL/@Initialize
1 MONITOR
2 BASIC
```

Or it might be much longer. However, if it is longer, its first few lines will look exactly like the above menu.

The above menu is three lines long, so you can see all of it on the screen at one time. But a menu might list as many as seventeen jobs-far too many to fit in one screen. How can you view such a long menu?

Just press the **RETURN** key. If additional items are stored in the menu, the screen will move *up*. If you continue to press **RETURN**, the menu will *scroll* up until it reaches the end of the list; then it will show you item “1” again.

To scroll text *down* down the screen, press the **SCRN** key (located near the upper right corner of the keyboard).

To understand what’s going on here, imagine that the menu is a long list written on a scroll of paper. This scroll is mounted on rollers in a box. A window in this box allows you to view a portion of the scroll. To view another part of the scroll, turn one of the wooden rollers.

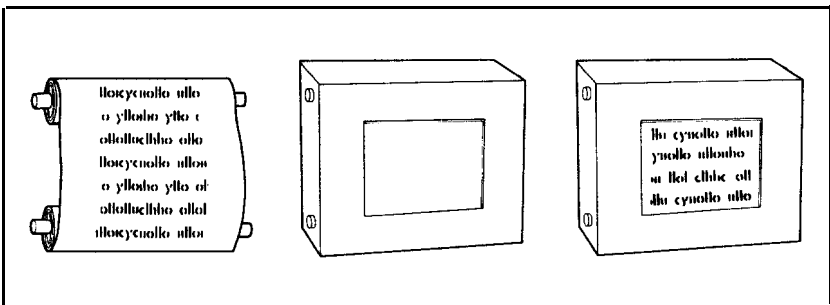

In a similar fashion, your HX-20 allows you to scroll the menu up and down through the screen. It won’t display a long menu all at once, but it will display any four-line portion of the menu. So the screen is a *window* onto the menu, just as the cutout in that cardboard box is a window onto the scroll. This allows you to read any menu, no matter how long it may be.

Table 4-1 lists the keys you may use to view the menu. (Note: these keys work as shown only when the menu is displayed. When the HX-20 is “in BASIC” or “in the MONITOR,” some of these keys have different functions.)

TABLE 4-1
Keys You May Use To View The Menu

Key	Effect
MENU	The entire menu will scroll up through the screen. When the scrolling stops, you will see item "1" in the top of the screen.
BREAK	Same as the MENU key.
RETURN	Text on the screen will scroll up by four lines. Once you have scrolled to the bottom of the menu, pressing RETURN will cause the menu to "roll around" to item "1". Thus, if you keep pressing RETURN , you can read through the menu again and again.
SCRN	Text on the screen will scroll <i>down</i> by four lines. (If the SCRN key has no effect, that means you are looking at the <i>top</i> of the menu.)
SHIFT / SCRN	Text on the screen will scroll <i>up</i> by four lines. (If SHIFT / SCRN has no effect, that means you are looking at the <i>bottom</i> of the menu.)
CTRL / PF2	The built-in printer will print a copy of what's on the screen (if the printer is switched ON).

If you press **CTRL** / **PF1**, and a microcassette cartridge is in place, then the menu will disappear. You may then control the microcassette manually. (See chapter 6.) To restore the menu, press **H**, **o**, **r**, **m**.

Incidentally, the arrow keys have no effect when you are viewing the menu.

Choosing an item from the menu

The menu lists jobs the HX-20 may perform. But how can you make the **HX-20** perform one of those jobs?

To answer that question, let's take a look at a particular menu:

```
CTRL/@Initialize
1 MONITOR
2 BASIC
```

(Press **SCRN** to see the top line of this menu on your screen.)

Each line in the menu lists a job the HX-20 may perform, by specifying a *key* and the job associated with that key. To choose an item from the menu, press the key listed next to that item. Thus, press **CTRL**/**@** to initialize the system, press **1** to select the Monitor, or press **2** to select BASIC. What could be simpler?

Some jobs are always available:

INITIALIZE Initialize memory and the calendar clock. See page 25.

MONITOR The monitor lets you enter and modify machine language programs. For more information, see the *Epson HX-20 Technical Reference Manual*.

BASIC BASIC lets you enter, change, and run BASIC programs. See the *Epson HX-20 BASIC Tutorial and Reference Manual*.

Your menu may list other jobs as well. For example, one or more jobs will be listed in your menu if you have installed *option ROM* for word processing, telecommunications, or some other application. The menu may also list BASIC and machine language programs that you have stored in memory.

When you press the key for a given item, the menu will disappear and the HX-20 will begin to perform the job you requested. Thus, the menu will no longer be active. Instead, the program you selected will be active. The HX-20 will not be “in the menu” any more, but will rather be “in BASIC,” or “in the MONITOR,” or in some other application. Instead of responding to the menu-viewing keys listed in Table 4-1, the HX-20 will respond only to keystrokes and commands recognized by the application you choose.

To use almost any application, however, you must learn to use the *screen editor*.

Chapter 5

The screen editor

When you use BASIC or almost any application program, you will interact with the HX-20 by typing on the keyboard, and it will respond by displaying text and graphics on the screen. This is made possible by the *screen editor*. Because the screen editor is central to almost all HX-20 applications, you can do little with the HX-20 until you learn how to use it.

Since the screen editor is so important, this chapter will show you how to use it in a “hands-on” fashion.

The virtual screen

The LCD screen can display four lines of text, with twenty characters per line. That won't let you display a lot of information.

That's where the screen editor comes in. By using the screen editor, the HX-20 can display information on a very large *virtual* screen. The virtual screen doesn't have a physical existence, like the LCD screen, but is rather an *imaginary* screen. You can think of it as lying just behind the LCD screen.

The dimensions of the virtual screen can vary according to the program you run, but in most cases the virtual screen will be eight lines high and forty characters wide—twice as high and twice as wide as the LCD screen itself. The LCD screen is merely a *window* onto this virtual screen. By pressing appropriate keys, you may move this window up, down, left, and right, thus bringing into view any desired portion of the virtual screen.

This means that you won't be limited by the size of the LCD screen, but can interact with the HX-20 *as if it had a much bigger display*.

How can a small window allow you to view the text on a large virtual screen? To understand how this works, tear page 37 out of this book, and use scissors to cut out the white box on that page.

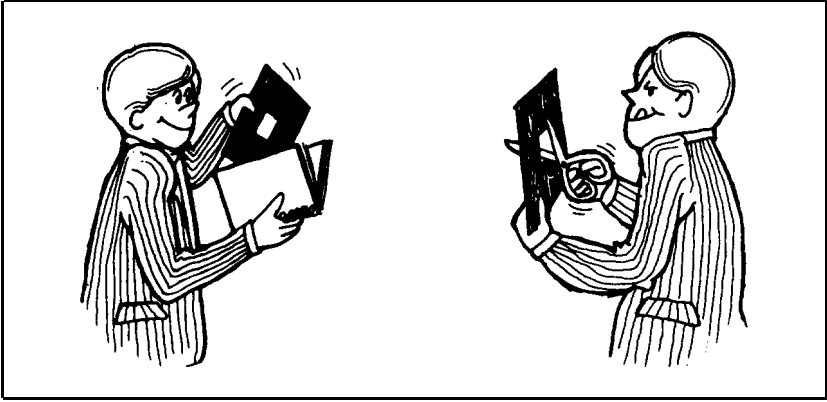

If you place that piece of paper on any page in this book, it will cover up all but a small portion of the page. Yet by moving that window horizontally and vertically, you can bring any desired portion of the page into view:

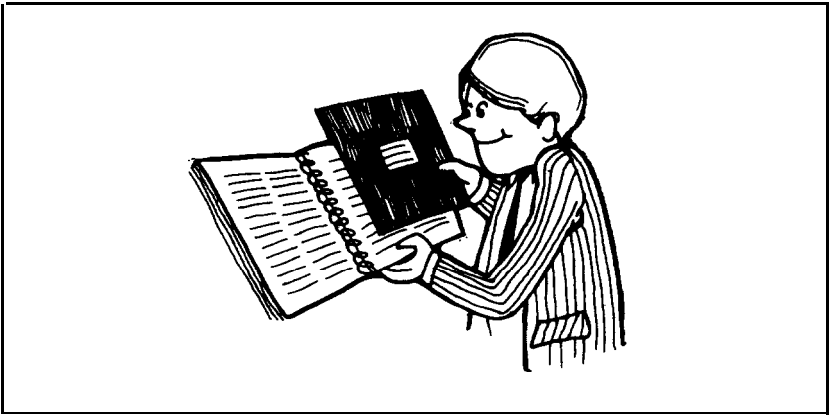

Moving the window does not change what's on the page. It just changes what's in the window. The text on the page is still there, whether you can see it or not.

In addition to letting you view any desired portion of the virtual screen, the screen editor will let you place words, numbers and character graphics on the virtual screen, and make it easy for you to *insert* and *delete* text at any point.

Turn on your HX-20 now and select BASIC from the menu. You won't actually learn any BASIC programming in the following pages, but you must enter BASIC in order to learn how to use the screen editor.

The cursor

When you select BASIC from the menu, a message will appear on the screen. For now, ignore that message.

At the bottom of the screen, you will see a symbol that looks like this:



That symbol consists of a “greater-than” sign with a little line underneath it. That little line is called a *cursor*.

On your keyboard, just above the **RETURN** key, you will notice two keys with arrows on them. These are the *cursor* keys. To see how they work, press this cursor key:



The cursor moves to the right, but the “greater-than” sign does not move. If you hold this key down, the cursor will move to the right repeatedly, stopping only when you release your finger from the key.

Virtually all keys on the keyboard have this automatic repeating action: the cursor keys, the letter, number, and punctuation keys, the space bar, and the **RETURN** key. This repeating action is a great convenience-but it also means that you must not rest your hands on the keys, for doing so will have the same effect as striking those keys repeatedly.

Now press this cursor key:



The cursor moves one space to the left. Use it to move the cursor back to its original position underneath the greater-than sign.

As you can see, it’s easy to move the cursor right and left. But how do you move the cursor up and down?

To move the cursor vertically, you must use a **SHIFT** key. For example, to move the cursor *up*, hold down a **SHIFT** key and press this key:



To move the cursor *down*, hold down a **SHIFT** key and press this key:



Thus, the **SHIFT** keys enable two cursor keys to move the cursor in any of *four* different directions: left, right, up, and down. To select horizontal movement, do not use a **SHIFT** key. To select vertical movement, you must use a **SHIFT** key.

Scrolling

Something special happens when you try to move the cursor beyond the edge of the LCD screen. The cursor doesn't move off the screen; instead, the cursor stays in place and the text on the screen moves in the opposite direction.

To see how this works, move the cursor down to the bottom row of the screen. When you try to move the cursor down one more time, the cursor doesn't move—instead, all the text on the screen *scrolls* up. In a similar manner, trying to move the cursor off the top or right edge of the screen will cause the text to scroll appropriately.

This scrolling demonstrates that the LCD screen is acting as a *window* onto the virtual screen. You can move the cursor anywhere you like within the virtual screen, and the text will scroll automatically, whenever necessary, to keep the cursor in view.

You can also scroll text with the **SCRN** key. Press the **SCRN** key and text moves *down* the screen. Hold down a **SHIFT** key and press **SCRN**, and text scrolls *up* the screen. Whether you use **SCRN** or **SHIFT/SCRN**, you will note that the cursor remains in its position on the LCD screen. (However, because **SCRN** and **SHIFT/SCRN** scroll the text vertically, they each move the cursor to a new line in the *virtual* screen.)

If you keep pressing the  key, you will discover at some point that it has no effect. This occurs when the LCD screen is displaying the *top* of the virtual screen.

Similarly, if you press **SHIFT/SCRN** enough times, at some point the LCD screen will display the *bottom* of the virtual screen. Pressing **SHIFT/SCRN** will then have no effect.

Homing the cursor

At any point you can move the cursor to the upper left corner of the virtual screen, by *homing* the cursor. To home the cursor, hold down a **SHIFT** key and press this key:

**HOME
CLR**

The LCD window will display the upper left portion of the virtual screen, and in the upper left corner of the window you will see the cursor. Bear in mind that homing the cursor does not change any of the text in the virtual screen, although it may cause a different portion of the virtual screen to appear in the window.

Clearing the screen

You can erase the entire virtual screen, just by pressing a single key:



This clears the virtual screen, and homes the cursor.

Typing on the virtual screen

Typing on the virtual screen is as easy as...well, as easy as typing. For example, let's say you want to type the expression, "NOW IS THE TIME FOR ALL GOOD MEN TO COME TO THE AID OF THEIR PARTY." (Don't type anything yet.) You've just pressed the  key, so you're looking at a blank screen, with a cursor in the upper left corner.

To begin typing the expression, press the [I'] key. Two things will happen: first, an "N" will appear on the screen at the cursor location, and the cursor will move one space to the right. So the screen will change from this:



to this:



The cursor shows you where the next character will appear. Each time you press a letter, number, or punctuation key, the corresponding character appears on the screen at the cursor location, and the cursor moves one space to the right.

This cursor behavior will continue for a while. When the cursor nears the right edge of the screen, however, something called *automatic scrolling* will occur.

Automatic scrolling

When you have typed the first 17 letters of the expression, your screen will look like this:

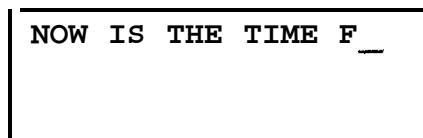

Because the cursor is near the right edge of the screen, something unusual will happen when you type the next character. Press them key. An “O” appears on the screen at the cursor location, but the cursor doesn’t move to the right. Instead, all the text on the screen slides to the left. So the screen will look like this:

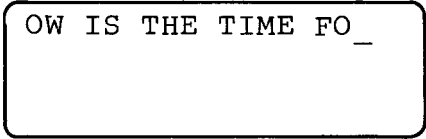



Type the letter “R” and it happens again! This hardly seems fair: each time you add a character on the right, you lose a character on the left. Or do you? In fact, the characters that have “disappeared” are still in the virtual screen, but you can’t see them because they’ve scrolled to the *left* of the LCD window.

You can bring those characters back into view with the cursor keys. Move the cursor far enough to the left, and the LCD window will move to the left, too, because the LCD window scrolls *automatically*, to keep the cursor in view. Thus, as the cursor moves to the left through the virtual screen, the LCD window will follow it, so that once again you will see the “missing” characters.

Virtual screen width

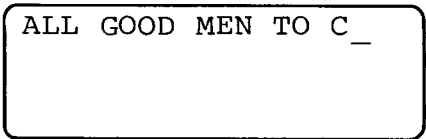
Using the cursor keys, place the cursor just to the right of the last character you’ve typed. Now continue typing your expression, Eventually the screen will look like this:



The next letter in the expression is “O”, and when you press the  key you might expect to see your text scroll horizontally yet again. But what happens? After an “O” appears at the cursor location, the text doesn’t scroll to the left. Instead, the cursor moves one space to the right. So the screen will look like this:

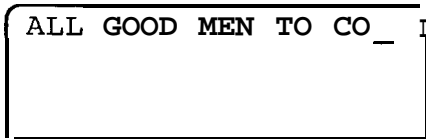

Your text didn’t scroll to the left, because the LCD screen was

already displaying the rightmost portion of the virtual screen.

Now, press the key and the screen will look like this:

```
ALL GOOD MEN TO COM_
```

The cursor is now in the rightmost location of the virtual screen. Now, press the key. The screen display changes dramatically:

```
NOW IS THE TIME FOR  
_
```

What happened? An “E” appeared in the virtual screen at the cursor location, and then the cursor advanced to the next location in the virtual screen. Since the cursor was already at the end of one line in the virtual screen, it advanced to the beginning of the next line.

The LCD window then moved *automatically*, to keep the cursor in view. This changed all the visible text, because the LCD screen was suddenly displaying a completely different portion of the virtual screen.

Logical lines vs. physical lines



When you finish typing “NOW IS THE TIME FOR ALL GOOD MEN TO COME TO THE AID OF THEIR PARTY.” the screen will look like this:

```
TIME FOR ALL GOOD M  
D OF THEIR PARTY. _
```

The text you typed occupies all of the first line and most of the second line of the virtual screen. Your cursor moved automatically to the second line of the virtual screen while you were typing, even though you never pressed the key.

The HX-20 moves the cursor to a new line whenever necessary. You may type one sentence that ends up occupying several lines of the virtual screen-without ever pressing the key. When this happens, we say that you have typed *one logical* line, which happens to occupy several *physical* lines.

To end one logical line and begin a new one, just press the key.

(You will see an error message on the screen if you press  now, after typing “NOW IS THE TIME FOR ALL GOOD MEN TO COME TO THE AID OF THEIR PARTY.” Here’s why: Pressing  tells the HX-20 that you have just completed a logical line. The HX-20 is in “BASIC,“ so it examines your line to see if it is a legitimate BASIC command. Since it can’t figure out what you’re asking it to do, it displays an error message. You’ll learn more about such error messages in the *BASIC Tutorial and Reference Manual*. But for now, ignore any BASIC error messages you encounter, because you’re still trying to learn how to use the screen editor.)

When you work with BASIC or with an application program, the HX-20 only pays attention to logical lines; it doesn’t care about physical lines. Therefore, the screen editor makes it easy for you to *insert* and *delete* characters within a logical line, but has no such features for inserting and deleting within a physical line.

Retyping

To *change* something you’ve typed, just move the cursor to the place where you want to make a change, and type the text you desire. When you *type over* existing text in this way, you replace the old text with the new text.

For example, let’s say you want to change the expression you had typed, from “NOW IS THE TIME FOR ALL GOOD MEN TO COME TO THE AID OF THEIR PARTY” to “NOW IS THE TIME FOR ALL GOOD MEN TO COME TO THE AID OF THEIR FRIENDS.”*



To make this change, use the cursor keys to locate the cursor on the “P” in “PARTY.” Then type “FRIENDS.” With those few keystrokes, you have changed the logical line.

Deleting text

To delete some characters altogether, place the cursor to the *right* of the character you wish to delete. Then press this key:



The character to the left of the cursor disappears, and the rest of the logical line moves one space to the left, to close up the gap.

To delete a group of characters, place the cursor to the right of the *last* character in the group, and press the  key repeatedly (or hold it down, thus making it repeat automatically). This will delete the characters in the group, one at a time, from right to left. When you’ve deleted the leftmost character, release the  key.

What could be easier? The characters you wished to delete will be gone, and there won’t be any gap in the logical line.

(Note: if the cursor is at the beginning of a logical line, then pressing **INS DEL** will not delete the preceding character, but will instead delete the character *at* the cursor.)

You will find the **INS DEL** key extremely helpful when you are typing new text. With it, you can correct typographical errors as soon as you make them. Whenever you strike the wrong key, press the **INS DEL** key immediately afterwards. That will move the cursor to the left, deleting the incorrect character. Then you can type the character you had intended to type, and continue from there.

Insert mode

Let's say you want to insert the word "NOT" into your expression, to make it read: "NOW IS NOT THE TIME FOR ALL GOOD MEN TO COME TO THE AID OF THEIR FRIENDS."

The screen editor makes it very easy for you to insert such text into a logical line.

Using the cursor keys, move the cursor to the point in your text where you want to insert new characters. When you've done so, the screen will look like this:

```
S THE TIME FOR ALL G
HE AID OF THEIR FRIE
```

Now you must enter *insert mode*. To do so, hold down a **SHIFT** key and tap the **INS DEL** key. (Just tap it-if you hold it down for more than a moment, you may find that you've *exited* from the insert mode before you've had a chance to use it.)

You won't notice any changes on the screen, but the HX-20 is now in insert mode. This means that any characters you type now will be *inserted* into the text at the cursor location. The rest of the logical line will *move to the right*, thus making room for the new character.

To see how this works, type the letter "N." Your screen will look like this:

```
S NTHE TIME FOR ALL
THE AID OF THEIR FRI
```

To finish inserting your text, press **0**, **T**, and then the spacebar. The screen will look like this:

```
S NOT THE TIME FOR A
TO THE AID OF THEIR
```

Eventually, you'll want to stop inserting text. To *exit* from insert mode, hold down a **SHIFT** key and tap **INS DEL** again. Or press any cursor key. Either action will take the HX-20 out of insert mode.

Upper and lower case
So far, you've only typed UPPER CASE LETTERS on the virtual screen. But with the screen editor, you can type lower case letters, too.

To explore the use of upper and lower case letters, begin by clearing the screen. This will give you a clean slate, making it easy for you to pay close attention to the letters you will type.

When you first enter the screen editor, it is in *upper case* mode. When you press a letter key, you will see the corresponding UPPER CASE letter on the screen. For example, press the **A** key. An UPPER CASE "A" will appear on the screen:



When the screen editor is in upper case mode, you can use the SHIFT key to produce lower case letters. To see how this works, press the **A** key *while you are holding down* a **SHIFT** key. You'll place a lower case "a" on the screen:



If you are accustomed to using a typewriter, this behavior may strike you as "backwards." After all, when you use a typewriter, you get lower case letters as a matter of course, and upper case letters only when you use a **SHIFT** key.

To make the screen editor handle the **SHIFT** key just like a typewriter, put the screen editor into *lower case* mode, by pressing this key:

**CAPS
LOCK**

The screen editor is now in lower case mode, as you can demonstrate by pressing the **H** key. (Leave your fingers *off* the **SHIFT** keys when you press "H.") A *lower case* "h" will appear on the screen:

Aah_

When the screen editor is in lower case mode, the **SHIFT** keys work the same way they do on a typewriter. Use no **SHIFT** key and you get a lower case letter; use either **SHIFT** key and you get an *upper case* letter.

To put the screen editor back into upper case mode, simply press the **CAPS LOCK** key again.

Numeric mode

When you use BASIC or run an application program, you may wish to type only *numbers*, instead of conventional text. You can, of course, type numbers by pressing the numeric keys in the top row of the keyboard.

But if you are accustomed to using a calculator or adding machine, you may find it awkward to use these keys. You might prefer the pattern of keys that you find on your calculator:

7 8 9
4 5 6
1 2 3
0

If so, do not despair. You won't have to teach your fingers a whole new pattern of numeric keys. Instead, just press the **NUM** key. Nothing will change on the screen, but the HX-20 is now *innumeric mode*, which changes the behavior of many keys.

For example, press the **U** key. Instead of placing a "U" on the screen, you'll see a "4" appear. Why?

If you look carefully at your HX-20 keyboard, you'll notice that small numbers appear in the upper right corner of several keys. These keys will generate those numbers when the HX-20 is in numeric mode. Thus, when the HX-20 is in numeric mode, this group of keys:

7 8 9
U I
J K L
M

will generate these numbers:

7 8 9
4 5 6
1 2 3
0

That's the same pattern of numbers you'll find on the keyboard of any calculator or adding machine.

When the HX-20 is in numeric mode, you cannot type any letters. (Go ahead. Press the  key. See? Nothing happens. In this mode, all letter keys are disabled.)

The number keys in the top row of the keyboard will also work—although presumably you put the HX-20 into numeric mode because you'd rather not use those keys. However, the numeric keys will not function if pressed in conjunction with a  key.

The following keys work normally when the HX-20 is in numeric mode:

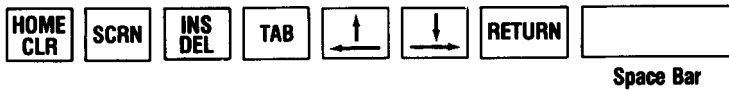









If you don't press a  key, the following keys will generate the indicated characters when the HX-20 is in numeric mode:

TABLE 5-1
Non-Numeric Characters
Available in Numeric Mode

<u>Press This KEY</u>	<u>To Create This CHARACTER</u>	<u>Description</u>
	-	Minus sign
	+	Plus sign
	*	Asterisk
	,	Comma
	.	Period
	/	Slash
	?	Question Mark

The above keys will not function if used in conjunction with a SHIFT key.





When you want to take the HX-20 out of numeric mode, just press the  key or the  key. If you press the  key, you will put the HX-20 into *upper case* mode. But if you end numeric mode by pressing , you'll put the HX-20 into *lower case* mode. Figure 5-1 summarizes the ways in which you may change screen editor modes.

Figure 5-1
Screen Editor Modes



Graphic characters

So far you've typed letters, numbers, and punctuation marks, but with the screen editor you may type many *graphic characters* as well. To generate these graphic characters, the screen editor must be in upper case mode, and you must use the **GRPH** key (located in the lower right corner of the HX-20 keyboard).

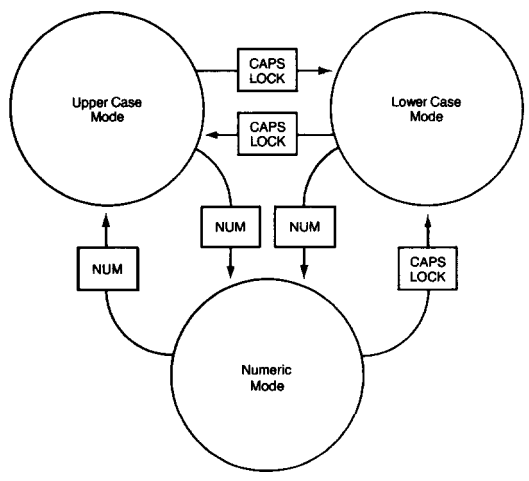
For example, hold down the **GRPH** key, and (while holding it down) press the **K** key. Instead of seeing a "K" or a "k" on the screen, you'll see a little *musical note*. Now hold down **GRPH** and press the letter "V". A tiny *telephone* appears. **GRPH** /i puts a small *person* on the screen. **GRPH** /m yields a *subcompact car*.

Figure 5-2 shows the graphic characters available from the keyboard. There are 32 graphic characters in all.



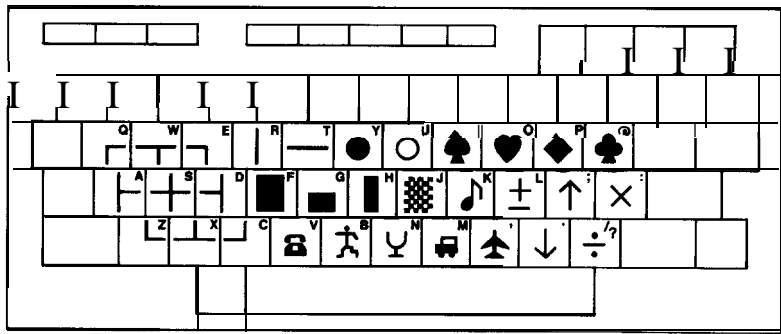

Figure 5-2
Graphic Characters Available From
HX-20 Keyboard



Printing the screen

Now you've learned enough to make the LCD screen display text and graphics. At some point, you may decide that you'd like to save a copy of what you see on the screen.

You can make a *hard copy* of the LCD screen whenever you'd like. To do *so*, you'll use one of the *specialfunction* keys, which are located just above the row of numeric keys on your HX-20 keyboard.

To print a copy of the LCD screen, just hold down the  key (located at the left edge of the keyboard) and press function key . The HX-20's built-in printer will activate and print a hard copy of the LCD display. (If / does not activate the printer, make sure that the printer has paper in it, and that the PRINTER ON-OFF switch, located just above the  key, is in the ON position.)

Once you've printed the screen, you may pull on the paper to bring your printout into view. (Or you may hold down the  key for this purpose-but that's slow, and uses battery power. Pulling on the paper will harm nothing as long as the printer is inactive.)













Note that / causes the printer to print a copy of the *LCD* screen, not the entire *virtual* screen. If you want hard copy of the entire virtual screen, you must scroll the LCD window through each portion of the virtual screen, and use / to print each portion of the virtual screen that you display in this manner.

TABLE 5-2
Screen Editor Key Functions

Key	Function
	Move cursor left by one column. Terminates insert mode.
	Move cursor right by one column. Terminates insert mode.
 / 	Move cursor up by one line. Terminates insert mode.
 / 	Move cursor down by one line. Terminates insert mode.
 / 	Move cursor left to a multiple of n columns. (Originally, $n = 10$, but n must be changed with the BASIC scroll command.)



Move cursor right to a multiple of n columns. (Originally $n = 10$, but n may be changed with the BASIC scroll command.)



Clear virtual screen and home the cursor.

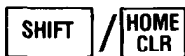

Home the cursor.



Move cursor right by 8 columns.



Scroll text up the screen by four lines (or by the amount set with the BASIC SCROLL command.)

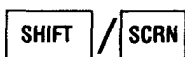

Scroll text down the screen by four lines (or by the amount set with the BASIC SCROLL command.)



Change modes:
upper case to lower case,
lower case to upper case, or
numeric mode to lower case.



If cursor is at beginning of a logical line, delete character at cursor. Otherwise, delete character to left of cursor.

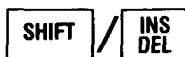

Enter insert mode. or exit from insert mode.



Enter numeric mode, or exit from numeric mode to upper case mode.



In conjunction with any key but a letter key, yields the upper character or function on the given key. In conjunction with a letter key, yields a lower case character if HX-20 is in upper case mode, or an upper case letter if HX-20 is in lower case mode.



If HX-20 is in upper case mode, pressing and another key yields a graphics character. In lower case or numeric mode, has no effect.

CTRL / A	Display leftmost portion of virtual screen.
CTRL / D	Scroll right.
CTRL / E	Delete from cursor to end of logical line.
CTRL / F	Move cursor to rightmost portion of virtual screen.
CTRL / H	Same as INS DEL
CTRL / I	Horizontal tab (8 columns).
CTRL / J	Move cursor down by one line. (Has no effect in BASIC immediate mode.)
CTRL / K	Home the cursor.
CTRL / L	Clear virtual screen and home the cursor.
CTRL / M	Carriage return.
CTRL / P	Scroll text down by four lines, or by amount set with BASIC SCROLL command.
CTRL / Q	Scroll text up by four lines, or by amount set with BASIC SCROLL command.
CTRL / R	Enter insert mode, or exit from insert mode.
CTRL / S	Scroll left.
CTRL / V	Make cursor visible.
CTRL / W	Make cursor invisible.
CTRL / Z	Delete from cursor to end of virtual screen.

Using the special function keys

Your HX-20 contains eight special function keys, labelled as follows:



PAUSE lets you change the rate at which the HX-20 LISTS a BASIC program on the screen. To change this rate, press **PAUSE** when a program is LISTING on the screen, and then press a key from 0 to 9. 0 sets the slowest LIST rate; 9 sets the fastest LIST rate. Other keys set intermediate LIST rates.

MENU lets you see the HX-20 menu. Even if the HX-20 is in BASIC, or is running some program, it will return to the menu if you press the **MENU** key.

BREAK interrupts an operation in progress, such as a BASIC program or a cassette SAVE or LOAD.

The keys **PF1** through **PF5** are *programmable* special function keys. This means that you can change the functions associated with these keys. See the *Epson HX-20 BASIC Tutorial and Reference Manual*.

CTRL/**PF2** causes the microprinter to print a hard copy of the LCD screen display.

CTRL/**PF1** enables you to control a microcassette manually. This works only when a microcassette is installed.

When you press **CTRL** / **PF1**, the LCD screen displays the value of the microcassette's digital tape counter. This indicates that the HX-20 is in *manual microcassette mode*. While in this mode, the programmable function keys have the following effect:

- PF1** : Fast forward.
- PF2** : Slow forward,
- PF3** : stop.
- PF4** : Rewind.
- PF5** : Exit from manual microcassette mode.
- SHIFT**/**PF1** Reset microcassette's digital tape counter to zero.

Chapter 6

Connecting your HX-20 to other devices

You can connect your HX-20 to a number of other devices—for example, to a cassette recorder, a printer, and a bar code reader, to name but a few. In this chapter you'll learn how to connect the HX-20 to such *peripherals*.

Connecting your HX-20 to a cassette recorder

You can connect your HX-20 to any portable cassette recorder. However, it's best to avoid the cheapest cassette recorders, because on these units the tape speed can fluctuate dramatically. Such fluctuations in tape speed can make it impossible for you to recover programs and data you have stored on your cassettes. To ensure a consistent tape speed, you should use fresh batteries if your cassette recorder is powered only by batteries, as the tape speed on these units will change as the batteries drain down. Even better, *use* an AC-powered cassette recorder, or get an AC adapter for your battery-powered unit.

One very desirable feature is a *digital tape counter*, which makes it easy to advance or rewind a cassette to the exact location of any previously-saved program or data file. Without a digital tape counter, you may only be able to save one program or data file on a cassette.

Tone and volume controls are also useful. A REM jack is essential for all but the simplest applications. A good quality micro-cassette recorder will serve as well as a unit that uses full-size cassettes.

Once you have a cassette recorder, you will need a cable to connect it to the HX-20. This cable, available from your Epson dealer as part #702, looks like this:

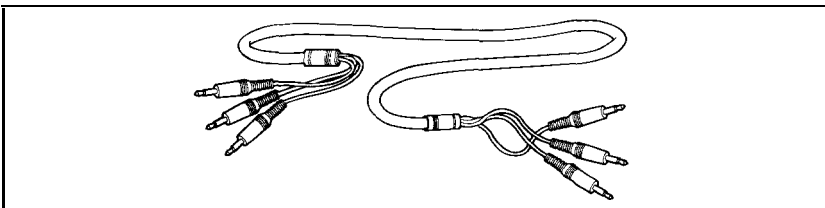

At each end of the cable you'll find three plugs, colored red, white, and black. Take the three plugs at one end of the cassette cable and plug them into the following sockets on the right side of the HX-20:

<u>P l u g</u>	<u>HX-20 Socket</u>
WHITE	EAR
RED	MIC
BLACK	REM

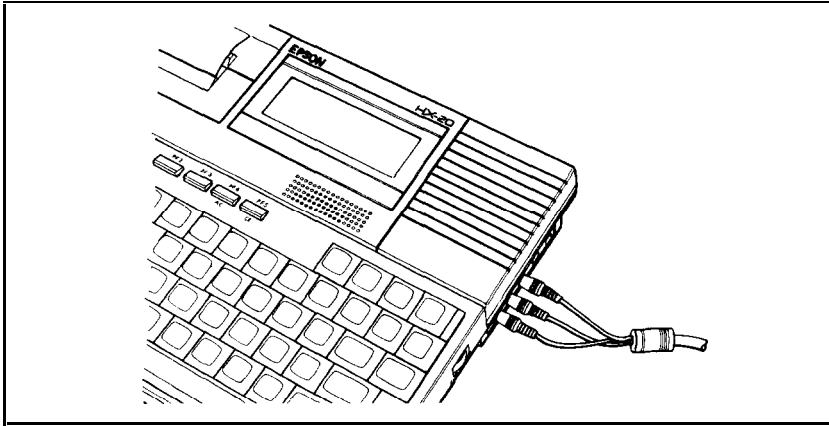

Now take the three plugs at the other end of the cassette cable and plug them into the corresponding sockets on your cassette recorder:

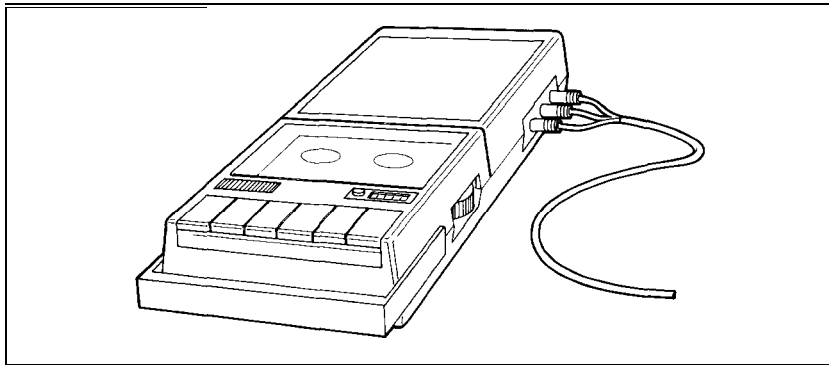

<u>P l u g</u>	<u>Cassette Recorder Socket</u>
WHITE	EAR
RED	MIC
BLACK	REM

If you wish, you may use separate patch cords to connect your cassette recorder to your HX-20: just connect REM to REM, MIC to MIC, and EAR to EAR.

Your cassette recorder is now connected to your HX-20. You may use it to save and load **BASIC** programs, as described in the *Epson HX-20 BASIC Tutorial and Reference Manual*. Or you may use it with various applications programs, as described in the documentation for those programs.

One word of caution: all cassette recorders vary, in tape speed and in the position of their record/ playback heads. These variations can be very frustrating, because a program recorded on one cassette recorder might not load back when you use another cassette recorder. You'll find that your cassettes work most reliably if you use only one cassette recorder with your HX-20.

Connecting your HX-20 to an RS-232 device

The RS-232 socket on the back of your HX-20 enables it to communicate with an external printer, modem, or other **RS-232 compatible device**. (Note that you cannot connect the HX-20 to a printer or other device that features only a *parallel* interface.) You can only connect the HX-20 to one RS-232 device at a time.

To connect such a device, purchase the appropriate HX-20 ,RS-232 cable from your Epson dealer. Then consult the documentation that came with your RS-232 device, and correlate it with the information in Table 6-1.

**TABLE 6-1
RS-232 Signals**

Signal	DIN Pin	DB-25 Pin
GND (Signal Ground)	1	7
TXD (Signal Out*)	2	2
RXD (Signal In*)	3	3
RTS	4	4
CTS	5	5
DSR	6	6
DTR	7	20
CD	8	8
Case Ground	DIN Case	1

* From HX-20's point of view.

(In Table 6-1, "DIN Pin" refers to pins in the 8-pin DIN socket labelled "RS-232" at the back of the HX-20, and "DB-25 Pin" refers to pins in the large trapezoidal plug you'll find at one end of the HX-20 RS-232 cable. This large plug is called a DB-25 connector.)

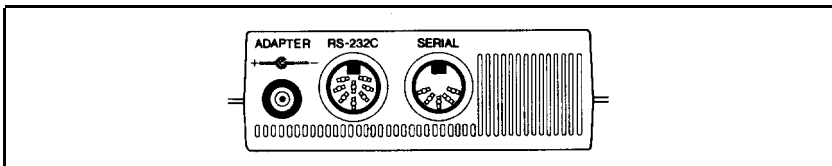

Plug the small, rounded end of the RS-232 cable into the DIN socket labelled “RS-232” in the back of your HX-20. Then plug the other end of the cable into the corresponding socket on your RS-232 device.

Now the HX-20 and the RS-232 device are connected. In order for them to *communicate*, however, they must share a common *protocol*. Two devices may be connected electrically, but never communicate properly, if they don’t share a common communications protocol. Try to configure your RS-232 device so that it will be compatible with the initial or default protocol of the HX-20, as defined in Table 6-2.

TABLE 6-2
HX-20 Default Protocol
for RS-232 Port

Data rate:	4800 Baud
Word length:	8 bits
Parity:	none
Stop bits:	2
CD (Carrier Detect):	ignored
RTS (Request to Send):	held “high” by HX-20
DSR (Data Set Ready):	controlled by external device; “high” means HX-20 may transmit data; “low” causes HX-20 to wait
CTS (Clear to Send):	ignored

If you configure the RS-232 device according to this protocol, you will find it very easy to transmit text and data to the device. However, by using appropriate parameters with the OPEN statement, you can command the HX-20 to use any desired protocol. (See the *Epson HX-20 BASIC Tutorial and Reference Manual*.)

Connecting your HX-20 to a bar code reader

On the right side of your HX-20, you will notice a socket marked “BAR CODE.”

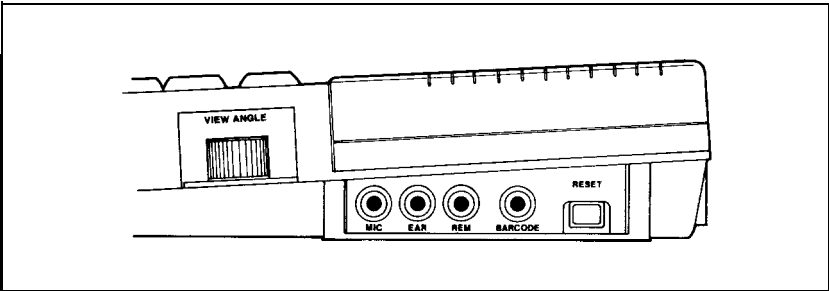

A bar code reader can “read” bar codes-those patterns of black and white stripes you find on groceries, magazines, and so many other products today.

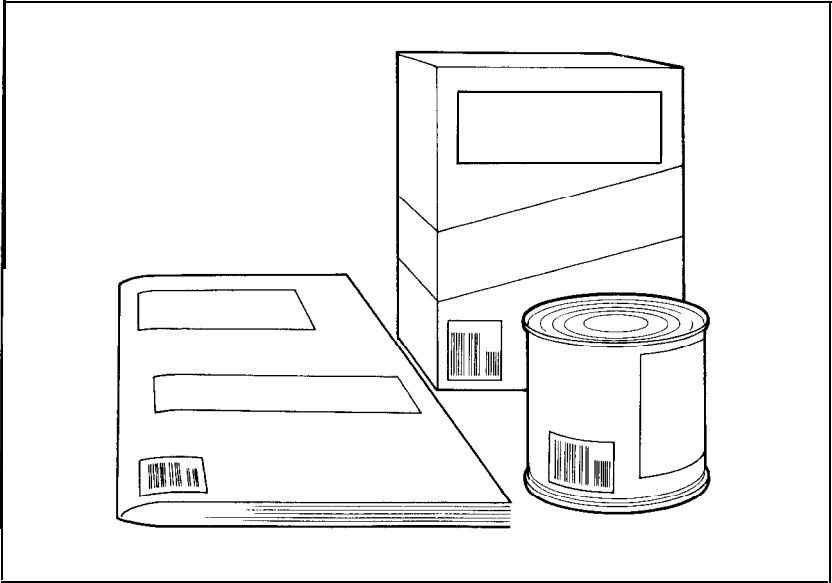

As of this printing, Epson has provided only the hardware interface for a bar code reader. But when you read this, a bar code reader might be available. Contact your Epson dealer. If you purchase a bar code reader, be sure to see what software is available for use with it.

Chapter 7

What if you have problems?

Your HX-20 is a highly sophisticated computer, controlled by very advanced software. Epson built reliability into this software, so it's quite likely that your HX-20 will give you trouble-free service for years. Nevertheless, even the most intelligent systems can become confused.

This chapter will show you what to do if your HX-20 fails to work properly.

If you can't turn off your HX-20...

Symptom: Text and/ or graphics remain on the screen, even when the ON-OFF switch is in the OFF position.

Cause: The "ON-OFF" switch does not shut off power, but merely *suggests* to the HX-20 that it stop processing. (If the ON-OFF switch *did* shut off power, turning it off would make the HX-20 forget every program in its memory!) For some reason, the HX-20 is so busy processing that it has failed to notice the position of the ON-OFF switch.

Recommended Action: With the power switch off, use your finger or a blunt object to press the RESET switch on the right side of the HX-20.

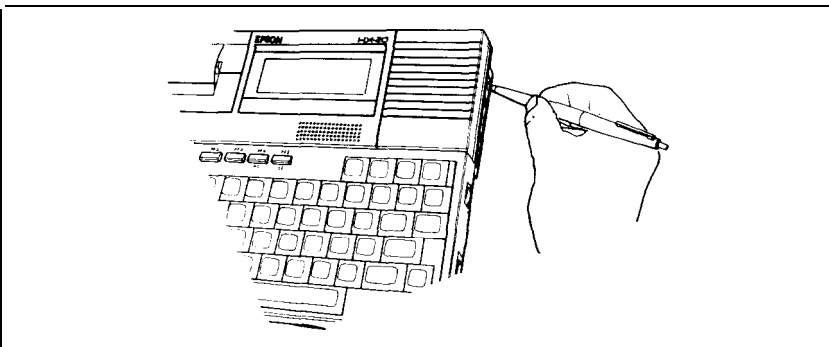

The RESET switch will interrupt the HX-20, no matter how busy it may be. Once interrupted, the HX-20 will notice that the ON-OFF switch is in the "OFF" position, and it will stop processing. This will make the screen go blank.

If the menu displays garbage...

Symptom: The menu displays garbage—a hodgepodge of letters, numbers, and/ or graphics characters.

Cause: The Operating System of the HX-20—the software that controls its menu—has become very confused. This may have been caused by a program that interfered with reserved portions of memory.

Recommended Action: Did you store any programs in memory? If so, select each program from the menu and LIST it. If any program is intact, take this opportunity to save it on a cassette. (See the *Epson HX-20 BASIC Tutorial and Reference Manual*.) Unfortunately, whatever garbled your menu may have garbled your programs, too. If the listings of your programs look like garbage, there's no point in saving them.

Now, to clean up your menu you must re-initialize memory and the calendar clock, as described on page 25. This will make the HX-20 start with a clean slate, forgetting any programs that were in its memory. But at least the menu will no longer have garbage in it.

Having re-initialized memory, you can once again enter your programs into the HX-20, by hand or by loading them from cassette.

If you encounter other problems...

If you encounter problems not discussed in this chapter, or if the recommended action fails to correct the problem, contact your Epson dealer.

Chapter 8

Storing your HX-20

Because of its sensitive components, the HX-20 requires some care even when you're not using it. This chapter tells you how to store your HX-20, for a few minutes, a few days, or even a few months.

Storing your HX-20...for a few minutes to a few hours

If you won't be using your HX-20 for a few minutes, you don't need to take any special precautions. You don't even need to turn it off. Just put it down, and pick it up again when you're ready to continue working with it.

Storing your HX-20...for a few hours to a few weeks

If you know that you won't be using your HX-20 for at least a few hours and perhaps for as long as a few weeks, turn it OFF before you put it away. When you come back to it and turn it on, you'll find that the program you were using is still in memory, ready for you to use again!

Just be sure to store your HX-20 in a place with acceptable temperature and humidity. (Remember-your car in the summer is likely to be much too hot for the HX-20. If you must store an HX-20 in your car during hot weather, put it in the trunk, which is likely to be cooler than the interior of the car itself.)

Storing your HX-20...for a few weeks to a few months

If you know that you won't be using your HX-20 for more than a few weeks, you must take certain precautions to ensure that the batteries won't drain down. You see, even when you turn the HX-20 OFF, it continues to draw a small amount of current from the batteries. This current keeps the memory circuits and calendar clock active.

Although the clock and the memory circuits require only a miniscule amount of power, they will discharge the batteries completely if given enough time. When that happens, the HX-20 will *forget* all the programs in its memory, and the batteries, once fully discharged, may no longer be able to accept a full charge.

Therefore, you should charge the batteries for several hours before storing the HX-20 for an extended period of time. It would

also be prudent to save on a cassette any programs you have stored in memory. Then store the HX-20 in its original box and packaging materials, in a place with acceptable temperature and humidity.

Chapter 9

Specifications

This chapter provides information of interest to technically-sophisticated users. If you are just learning about computers, ignore this chapter. Turn instead to the *Epson HX-20 BASIC Tutorial and Reference Manual*, and learn how to program your HX-20. For detailed specifications, *see* the *Epson HX-20 Technical Reference Manual*. All specifications are subject to change without notice.

Architecture

The HX-20 has two microprocessors for distributed and concurrent I/O processing. The microprocessors (both 6301's) communicate with each other through their serial communications ports.

As shown in Figure 9-1, the main microprocessor accesses read-only and read-write memory, and controls the keyboard, LCD display, and clock. The slave microprocessor controls the micro-printer, speaker, and external cassette. The cartridge interface has ports for both the main and slave microprocessors.

Figure 9-1
HX-20 Architecture

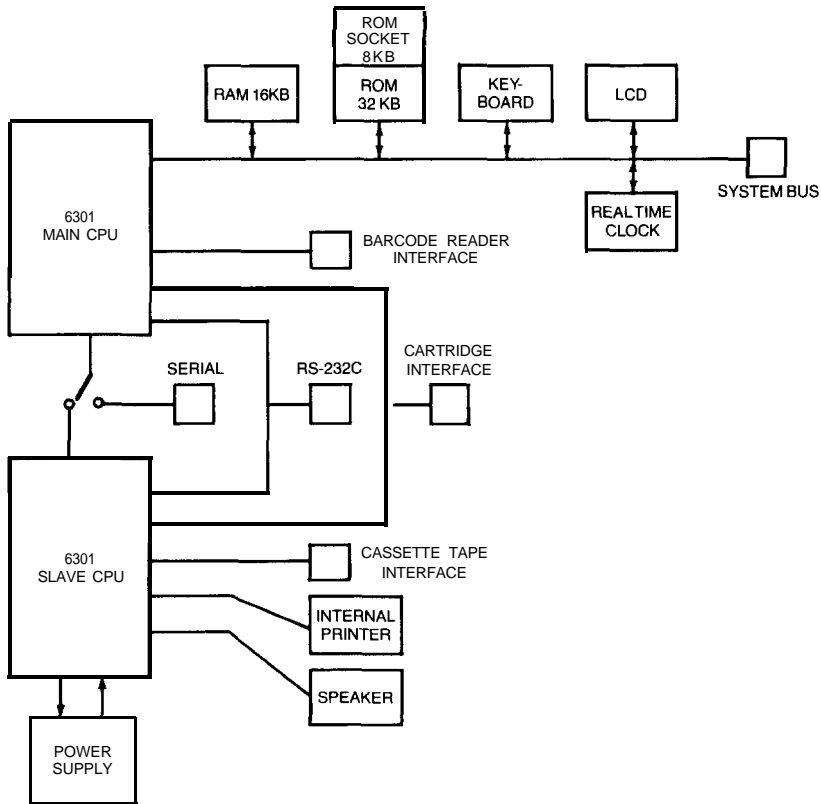

Expansion

Several options may be easily installed to expand the HX-20's capability, as shown in Figure 9-2. An expansion unit provides an additional 32K of memory, which includes 16K of RAM. In addition, an 8K application ROM may be installed internally. An option ROM or microcassette cartridge may be installed in place of the dummy cartridge.

Connectors located at the back of the HX-20 enable it to be connected to a printer with a serial interface, a computer, or a modem; and to a floppy disk unit and display controller via a serial bus. A bar code reader and external cassette recorder may be plugged into connectors located on the right side of the HX-20.

Figure 9-2
HX-20 Expansion

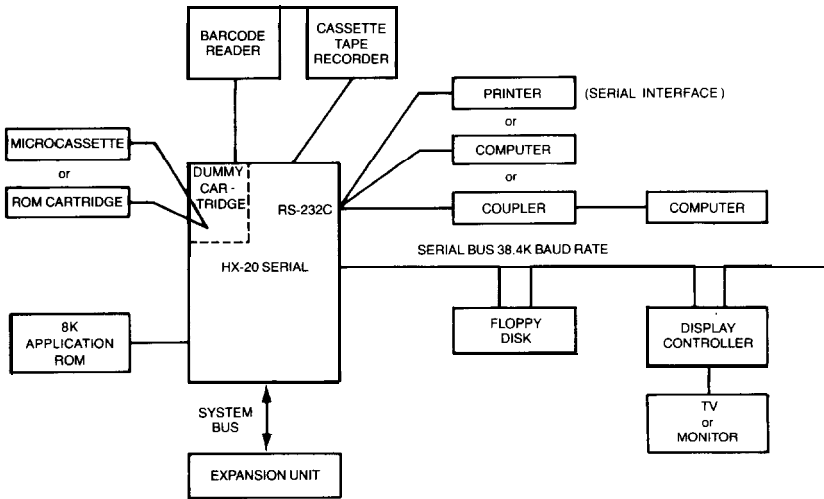

Specifications

CPU and Memory

Main CPU	CMOS 8 bit 6301 microprocessor 614 KHz clock rate
Slave CPU	CMOS 8 bit 6301 microprocessor, 614 KHz clock rate
RAM	16K standard
ROM	32K standard

Internal Expansion

ROM	8 K in option ROM for a total of 40 K
-----	--

External Expansion

RAM	16K (See "Options")
ROM	32K (See "Options")

Built-in Features

Display	Liquid Crystal Display; 120 x 32 dot-addressable matrix; 5 x 7 font; virtual width to 255 characters by BASIC WIDTH command
Printer	24-column dot matrix impact microprinter; graphic print rate: 42 lines per minute; bit addressable graphics; full ASCII upper and lower case character set; cartridge ribbon; plain paper, 55mm wide
Clock	Time and calendar, alarm, interval timer, battery backup
Speaker	Piezoelectric; programmable pulse drive; four octaves with half-tones

Interfaces

Interface Power Capacity

(each pin and total)	
VB (direct from battery)	1.0 A
+5V (switched)	50 mA
VC (Power for RAM)	40 mA

Communications

RS-232C

(Full and half duplex)	
Connector	8-Pin DIN
Input/ Output Level	EIA RS-232C standard
Baud Rates	110, 150, 300, 600, 1200, 2400, 4800
Pin Assignment	1: GND, 2: TXD, 3: RXD, 4: RTS, 5: CTS, 6: DSR, 7: DTR, 8: CD; CG= Case Ground

Serial

(Full and half duplex)

Connector

5-Pin DIN

Input/ Output Level

EIA RS-232C standard

Baud Rates

150, 600, 4800, 38400

Pin Assignment

I: GND, 2: TXD, 3: RXD, 4:
OUT. 5: IN CG= Ground

Peripheral

Cartridge

Connector

Special-Epson

Input/ Output Level

TTL

Pin Assignment

1: SII, 2: SI/011, 3: S01, 4: SI/02,
5: SI/03,6: SI/04,7: VB(Battery),
8: MII, 9: M02, 10: M01, II:
GND, 12: +5V (Switched)

Cartridge Type

ROM Cartridge

MI1	SI1	S/O1
-----	-----	------

Not assigned

0	0	0
---	---	---

No cartridge

0	0	
---	---	--

Not assigned

0		0
---	--	---

Microcassette

	*	*

(* Doesn't matter)

External Cassette

Microphone

Miniature phone jack

Earphone

Miniature phone jack

Remote

Subminiature phone jack

Bar Code Reader

Connector

HSJ0861-01-440 (Seidenki)

Input Level

TTL

System Bus

Connector

40-Pin

Address Bus

16 bit

Data Bus

8 bit and control lines

Power Supply

Batteries

Type

Four NiCad batteries, internal,
Sub C type

Capacity

1100 mA/ H (Approximately 50
hours running BASIC; less de-
pending on use of RS-232C port,
printer or optional microcassette)

Operation

4.5-6.0 V

Data Integrity

4.0-6.0 V

Low Voltage

4.5 v

Recharge

Full charge within eight hours at
typical room temperature

AC Adapter (Battery Charger)	
Input Voltage	115V AC \pm 10%
Frequency	49.5-60.5 Hz
Consumption	8 Watts
Isolation	8 Megaohms, case to AC; 1 KV, 1 min., case to AC
Switches	
Internal	4 Bit DIP; 3 bits for international character set selection, 1 bit for selecting Disk or ROM BASIC
External	Main Power; Printer On/Off; Reset
Keyboard and Character Set	
Type	ASCII
Function	Interruptible
Total Number of Keys	68
Function Keys	5
Special Keys	13
Ten Key Numeric Pad	Function locked in by (N U M) key
Graphic Shift	32 special graphic characters
International Character Set	Selectable by DIP switch or software
Environmental	
Temperatures	
Operating	5-35° C (41-95° F)
Charge	5-35°C (41-95° F)
Data Integrity	-5-40° C (22-104° F)
Data Storage	-20-60° C (-5- 140° F)
Humidity	
Operating/ Non-operating	10-80% non-condensing
Vibration without Microcassette	
	0.25 G, 55 Hz max.
Shock	1 G for 1 ms max.
Physical Characteristics	
Size	28.9 x 21.6 x 4.44 cm (11.375" x 8.5" x 1.75")
Weight	1.73 kg (3 lbs. 13 oz.)
Options	
Cartridge	
Microcassette Cartridge	H20MC
ROM Cartridge	H20RC
Expansion Unit	
RAM Capacity	16K
ROM Capacity	16K (Bank-switched with BASIC ROM's)

CX-20 Acoustic Coupler	
Communications	Full/ half duplex, selectable
Operation Mode	ORIG/ ANS mode, selectable
Signaling Speed	Up to 300 BPS
Interface	Standard RS-232C
Power Supply	4 NiCad batteries; AC adapter/ charger (1 15V \pm 10%, 60 Hz); Floating charge with AC adapter
Display Controller	H00DC-IA
Switch Box	H00SB-JA
RS-232C Cables	**
Serial Cables (High Speed)	**
External Cassette Cable	H-702
Support	
AC Adapter (Battery Charger)	H00AAA
Roll Paper	H00RP
Ribbon Cartridge	H00CR-BA
	(** See your Epson Dealer)