

CNY75AX, CNY75BX, CNY75CX,
CNY75A, CNY75B, CNY75C



**OPTICALLY COUPLED
ISOLATOR
PHOTOTRANSISTOR OUTPUT**

APPROVALS

- UL recognised, File No. E91231
- 'X' SPECIFICATION APPROVALS
 - VDE0884 in 3 available lead forms : -
 - STD
 - G form
 - SMD approved to CECC 00802
 - Certified to EN60950 by the following Test Bodies :-
 - Nemko - Certificate No. P96101299
 - Fimko - Registration No. 190469-01..22
 - Semko - Reference No. 9620076 01
 - Demko - Reference No. 305567

DESCRIPTION

The CNY75A, CNY75B, CNY75C series of optically coupled isolators consist of infrared light emitting diode and NPN silicon photo transistor in a standard 6 pin dual in line plastic package.

FEATURES

- Options :-
 - 10mm lead spread - add G after part no.
 - Surface mount - add SM after part no.
 - Tape&reel - add SMT&R after part no.
- High BV_{CEO} (90V min)
- High Isolation Voltage ($5.3kV_{RMS}$, $7.5kV_{PK}$)
- All electrical parameters 100% tested
- Custom electrical selections available

APPLICATIONS

- DC motor controllers
- Industrial systems controllers
- Measuring instruments
- Signal transmission between systems of different potentials and impedances

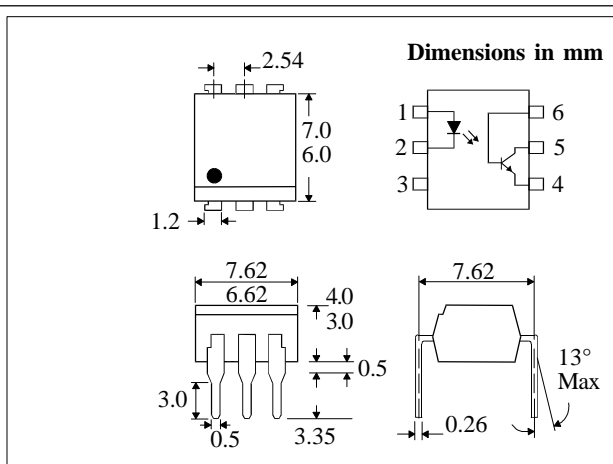
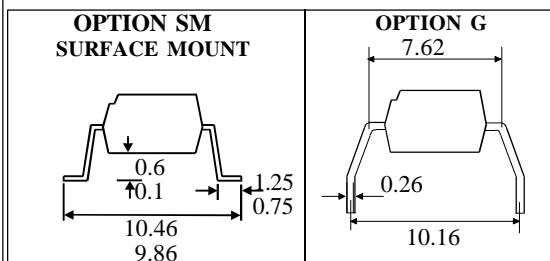

**ABSOLUTE MAXIMUM RATINGS
(25°C unless otherwise specified)**

Storage Temperature	-55°C to + 150°C
Operating Temperature	-55°C to + 100°C
Lead Soldering Temperature (1/16 inch (1.6mm) from case for 10 secs)	260°C

INPUT DIODE

Forward Current	60mA
Reverse Voltage	6V
Power Dissipation	105mW

OUTPUT TRANSISTOR

Collector-emitter Voltage BV_{CEO}	90V
Collector-base Voltage BV_{CBO}	90V
Emitter-collector Voltage BV_{ECO}	6V
Power Dissipation	160mW

POWER DISSIPATION

Total Power Dissipation	200mW
(derate linearly 2.67mW/°C above 25°C)	

ISOCOM COMPONENTS LTD
Unit 25B, Park View Road West,
Park View Industrial Estate, Brenda Road
Hartlepool, TS25 1YD England Tel: (01429)863609
Fax: (01429) 863581 e-mail sales@isocom.co.uk
http://www.isocom.com

ISOCOM INC
1024 S. Greenville Ave, Suite 240,
Allen, TX 75002 USA
Tel: (214) 495-0755 Fax: (214) 495-0901
e-mail info@isocom.com
http://www.isocom.com

ELECTRICAL CHARACTERISTICS ($T_A = 25^\circ\text{C}$ Unless otherwise noted)

PARAMETER		MIN	TYP	MAX	UNITS	TEST CONDITION		
Input	Forward Voltage (V_F)		1.2	1.60	V	$I_F = 50\text{mA}$ $I_R = 10\mu\text{A}$ $V_R = 6\text{V}$		
	Reverse Voltage (V_R)	6			V			
	Reverse Current (I_R)			10	μA			
Output	Collector-emitter Breakdown (BV_{CEO}) (Note 2)	90			V	$I_C = 1\text{mA}$		
	Collector-base Breakdown (BV_{CBO})	90			V	$I_C = 100\mu\text{A}$		
	Emitter-collector Breakdown (BV_{ECO})	6			V	$I_E = 100\mu\text{A}$		
	Collector-emitter Dark Current (I_{CEO})			150	nA	$V_{CE} = 20\text{V}$		
Coupled	I_C / I_F (CTR) (Note 2)	CNY75A	15			%	$1\text{mA } I_F, 5\text{V } V_{CE}$	
		CNY75B	30			%	$1\text{mA } I_F, 5\text{V } V_{CE}$	
		CNY75C	60			%	$1\text{mA } I_F, 5\text{V } V_{CE}$	
	Collector-emitter Saturation Voltage $V_{CE(SAT)}$	CNY75A	63		125		%	$10\text{mA } I_F, 5\text{V } V_{CE}$
		CNY75B	100		200		%	$10\text{mA } I_F, 5\text{V } V_{CE}$
		CNY75C	160		320		%	$10\text{mA } I_F, 5\text{V } V_{CE}$
	Input to Output Isolation Voltage V_{ISO}		5300		0.3	V	$10\text{mA } I_F, 1\text{mA } I_C$	
			7500			V_{RMS} V_{PK}	See note 1	
	Input-output Isolation Resistance R_{ISO}		5×10^{10}			Ω	$V_{IO} = 500\text{V}$ (note 1)	

Note 1 Measured with input leads shorted together and output leads shorted together.

Note 2 Special Selections are available on request. Please consult the factory.

Type	$R_L = 100\Omega$ see fig 1							$R_L = 1\text{k}\Omega$ see fig 2		
	td	tr	ton	ts	tf	toff	I_C	ton	toff	I_F
	μs	μs	μs	μs	μs	μs	mA	μs	μs	mA
CNY75A	2.0	2.5	4.5	0.3	2.7	3.0	10	10	25	20
CNY75B	2.5	3.0	5.5	0.3	3.7	4.0	10	16.5	20	10
CNY75C	2.8	4.2	7.0	0.3	4.7	5.0	10	11	37.5	10

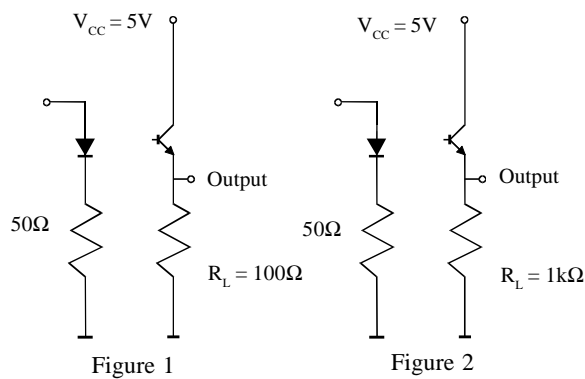

Collector Power Dissipation vs. Ambient Temperature

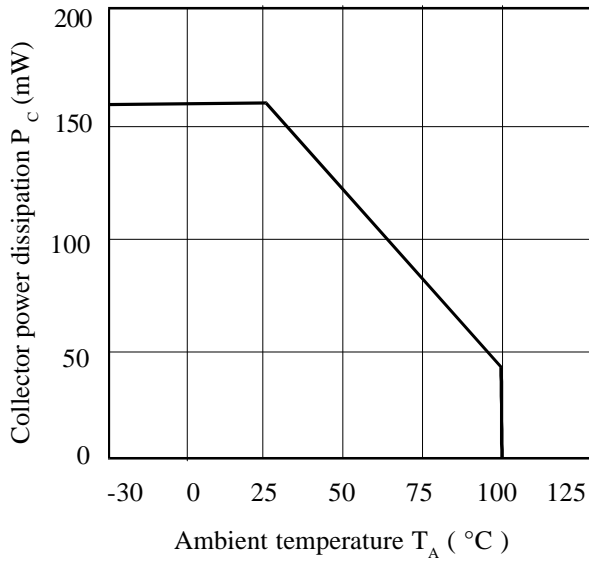

Collector Current vs. Collector-emitter Voltage (normalised to CNY75B)

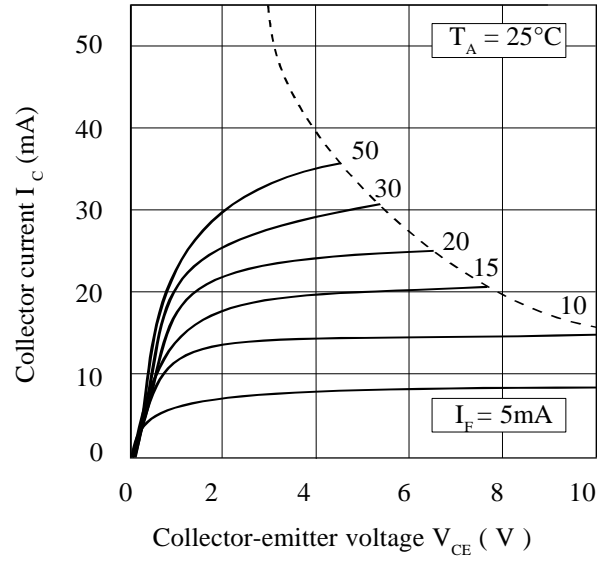

Forward Current vs. Ambient Temperature

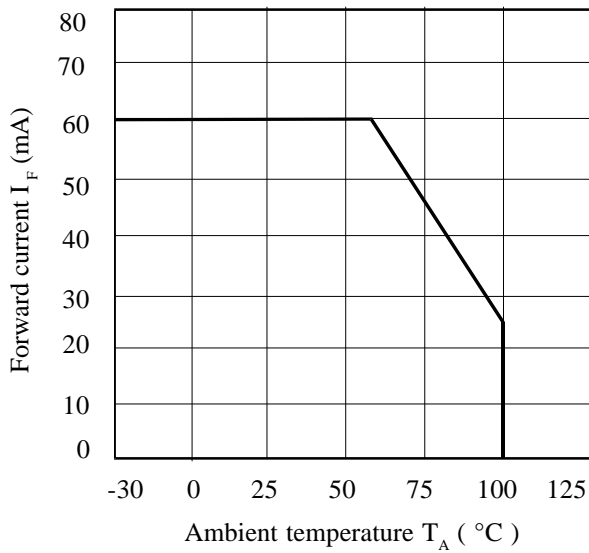

Current Transfer Ratio vs. Forward Current

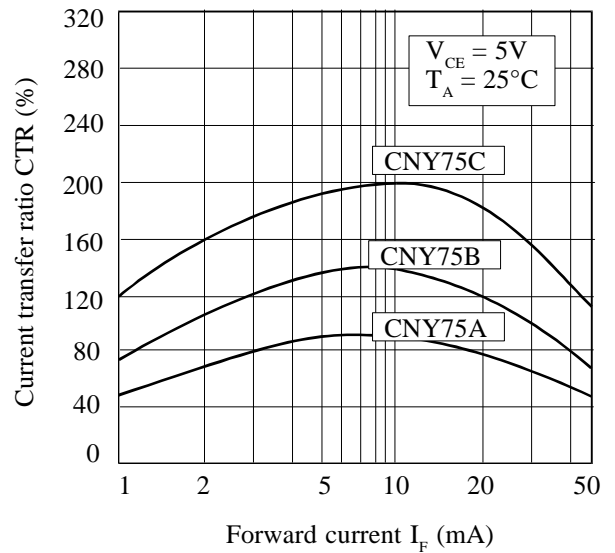

Relative Current Transfer Ratio vs. Ambient Temperature

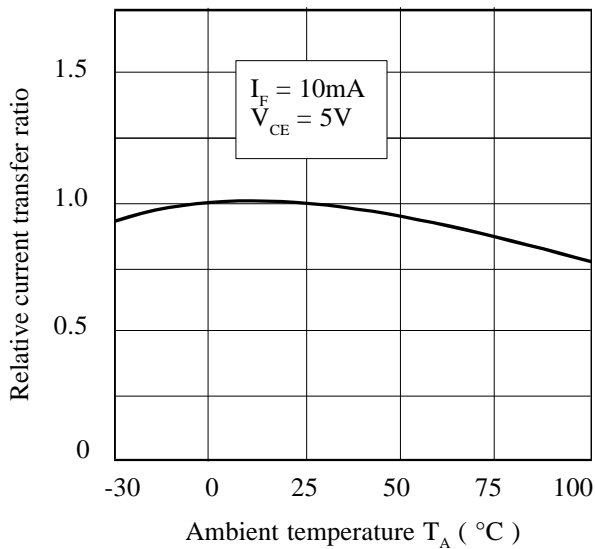

Collector-emitter Saturation Voltage vs. Ambient Temperature

